

# EVOLUTION AND FUNCTIONAL MORPHOLOGY OF THE CYSTOID *SPHAERONITES* IN BRITAIN AND SCANDINAVIA

by C. R. C. PAUL and J. F. BOCKELIE

**ABSTRACT.** The directly attached diploporite cystoid *Sphaeronites* is characterized by a closely approximated mouth and anus on an oral platform, and densely developed diplopores. Three subgenera are recognized: *Sphaeronites s.s.* (lower Ordovician, Sweden); *Peritaphros* (middle and upper Ordovician, Britain, Norway, Sweden, Baltic States); *Ataphros* subgen. nov. (upper Ordovician, South Wales). Early species occur in 'Sphaeronites beds' with few other echinoderms. Later species are less abundant, but occur with a more diverse echinoderm fauna. *Sphaeronites* shows evolutionary trends towards increased plate thickness and plate size (hence reduced number of plates per theca), increased anal area (and inferred food processing capacity), and decreased diplopore density. Diplopore structure also evolved. Those of *Sphaeronites s.s.* are deeply sunken with blunt spines on the rims; *Peritaphros* diplopores have a large central tubercle surrounded by a moat-like channel but no rim spines; *Ataphros* diplopores have just the central tubercle. Changes in diplopores have been investigated using computer programs to simulate respiratory gas exchange. The larger, less densely packed diplopores of later species achieved the same respiratory capacity, but with individually more efficient diplopores. Reconstructions of the soft tissue cover of diplopores confined to the moat-like channels of *Peritaphros* or covering the central tubercle as well, yielded respiratory capacities 10% and 100% of *Sphaeronites s.s.* The maximum calculated evolutionary increase in saturation with O<sub>2</sub> of body fluids occurred with soft tissue covers 20 μm thick. It is inferred that these covers were 10–50 μm thick in life. Calculation of food processing capacity suggests that *Sphaeronites* could gather all the food they could metabolize with simple, unbranched appendages (?brachioles) of a length equal to the thecal diameter. Computer programs offer a powerful tool in reconstructing unpreserved parts of fossils essential to functional interpretations.

*Sphaeronites* is revised systematically. Nine species are recognized of which one is left under open nomenclature and the following are new: *S. (Sphaeronites) minor*, *S. (Peritaphros) pauciscleritatus*, *S. (P.) variabilis*, and *S. (Ataphros) insuliporus*.

*SPHAERONITES* was a directly attached diploporite cystoid genus which survived throughout the Ordovician from the Arenig to the Ashgill and is found in Britain, Scandinavia, and the Baltic States. It is type genus of the family Sphaeronitidae and superfamily Sphaeronitida. The type species of *Sphaeronites*, *Echinus pomum* Gyllenhaal, 1772, was one of the first two cystoids ever described. Historically and taxonomically *Sphaeronites* is an important genus. In this paper we revise the genus, document its evolutionary trends, and show that *Sphaeronites* is also very important in an evolutionary context.

We first became interested in the genus independently, in the course of revising British (CRCP) and Norwegian (JFB) Ordovician cystoid faunas, respectively. Also independently, we realized that the Swedish cystoid figured by Regnéll (1945, pl. 15, fig. 1) as 'Gen. & sp. indet.' was a new species of *Sphaeronites*. On discovering our joint interest we combined to revise the genus thoroughly in Britain and Scandinavia, considering its stratigraphical and geographical occurrences, functional morphology, mode of life, and evolution. Paul (1972, 1973) had already documented an evolutionary trend in diplopore density, and the functional significance of this trend has been investigated quantitatively using computer programs to simulate gas exchange. As a result of this study we recognize eight named species, four new, in three subgenera, one new. The evolutionary trend in diplopore density achieved the same respiration rate with progressively fewer, but individually more efficient, diplopores. Computer-generated quantitative estimates of respiration rates have also enabled us to reconstruct some unpreserved parts of the fossils, namely the cover of the diplopores and feeding

organs, with more certainty than was previously possible. Computer models offer a powerful tool in the study of functional morphology in extinct groups of fossils such as the cystoids. Since this study is largely concerned with the evolution of *Sphaeronites*, we consider first its geographical and stratigraphical occurrence, in order to establish the sequence of species.

### OCCURRENCES

The principal localities for *Sphaeronites* are illustrated in text-fig. 1. All are Ordovician and range in age from upper Arenig to middle Ashgill. Correlation of *Sphaeronites*-bearing horizons is presented in text-fig. 2. Stratigraphical information on specific localities is given below, while palaeoecological information is given later. The localities discussed here provide the best evidence for the ages of the species which can be attributed to *Sphaeronites* as we understand the genus. The reasons for accepting only these species within the genus *Sphaeronites* are discussed in the systematic section.

Shoeshook, near Haverfordwest, Dyfed, South Wales (loc. 1, text-fig. 1). Paul (1973, fig. 5), presented a section through the Shoeshook Limestone together with known occurrences of cystoids, including *S. litchi* (Forbes). Price (1973, 1980) has discussed the trilobite fauna and correlation of the Shoeshook Limestone. In the later paper Price considered that at the type locality the Shoeshook Limestone ranges in age from low Ashgill, zone 2 possibly up to zone 5 (i.e. Cautleyan to Rawtheyan). The enigmatic diploporite described as 'Incertain sedis sp. D' (Paul 1973, p. 61) has since been found to represent a new species of *Sphaeronites*, *S. (Ataphros) insuliporus*, known only from the Shoeshook Limestone. Both species appear at almost the same level, between 11 and 13 m, and disappear at the same level, about 37 m in the section. *S. (P.) litchi* is also known from the Rhiwlas Limestone which is Rawtheyan (Ashgill, zone 5).

Rhiwlas and Llwyn-y-Ci, near Bala, Gwynedd, North Wales (loc. 2, text-fig. 1). Bassett *et al.* (1966, p. 252) report a total thickness of 6.4 m of Rhiwlas Limestone at the type section. The fauna indicates a middle Rawtheyan age according to Bassett (*in Williams et al.* 1972, fig. 5). *S. puriformis* (Forbes) is not uncommon in

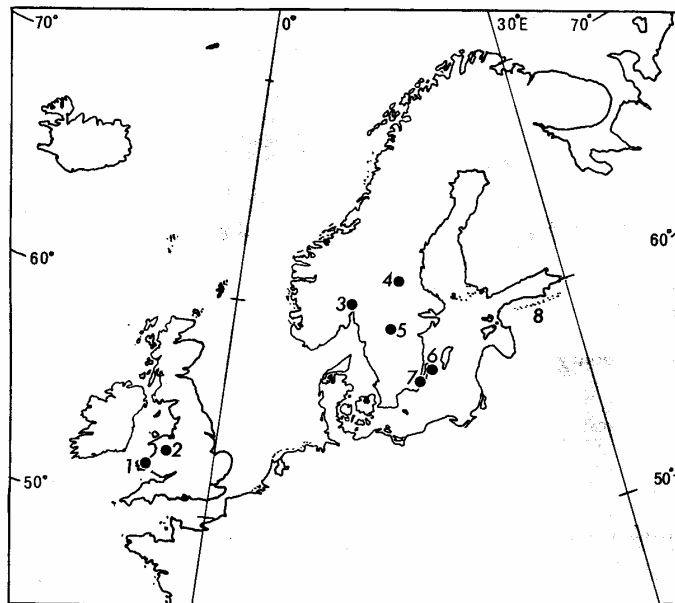

TEXT-FIG. 1. Map of north-west Europe showing the principal localities for *Sphaeronites*. For details of localities, see text.

SERIES	British stages	Graptolite zones	Oslo-Asker Stages	South & Central Sweden Stages	WALES	NORWAY	SWEDEN			
Ashgill	Hirnantian	?	Calc. sandstones	Boda Imst.	S. (P.) lichi - - - ■ S. (P.) pyriformis ■ S. (A.) ■					
	Rawtheyan							D. anceps	Gastropod Imst.	Tommarp
	Cautleyan	D. complanatus	Isotelus sp.	Nittsjö						
	Pusgillian			P. linearis				Tretaspis sh.	Jonstorp	
Caradoc	Onnian	D. clingani	U. Chasmops Imst.	Slandrom Imst.	S. (P.) pauciscleritatus ■	S. (P.) pauciscleritatus ■				
	Actonian							U. Chasmops sh.	Kullsberg Imst.	Macrourus Imst.
	Marshbrookian									
	Longvillian	C. wilsoni	L. Chasmops sh.	Dalby Imst.						
	Soudleyan	C. peltifer								
	Harnagian	?	Ampyx Imst.	Furudal Imst.						
	Costonian							N. gracilis	Folkeslunda Imst.	
Llandeilo	upper	G. teretiusculus	U. Didymograptus sh.	Segerstad Imst.	S. (S.) minor ■	S. (S.) pomum ■	S. (P.) globulus ■			
	middle							D. purchisoni	Orthoceratite Imst.	
	lower							D. bifidus		reddish Imst.
Llanvirn	upper	D. hirundo	L. Didymograptus sh.	reddish Imst.	S. (P.) variabilis - - - ■					
	lower							D. extensus	Billingen Imst.	
Arenig	upper	D. extensus	L. Didymograptus sh.	Hunneberg Imst.						
	lower									

TEXT-FIG. 2. Correlation diagram showing stratigraphical ranges of the species of *Sphaeronites* dealt with in this paper.

old collections from Rhiwlas Manor and Llwyn-y-Ci (locs. 6/1 and 6/3 of Paul 1973, p. 8). We have collected about ten more specimens from loose blocks which once formed the walls of the old Ffryddan Factory.

Asker and Bærum, Norway (loc. 3, text-fig. 1). *S. pauciscleritatus* sp. nov. occurs commonly in a 1 m band in the middle of the lower Chasmops Limestone (Stage 4bβ), a sequence with approximately 50% limestone nodules and 50% shale. The lower Chasmops Limestone probably correlates with the Soudleyan-Longvillian boundary (middle Caradoc). Even though the lithologies have a wide geographical distribution (Størmer 1953), *S. pauciscleritatus* has a limited occurrence on the mainland and islands west of Oslo (Asker and Bærum districts, text-fig. 3) in what may have been an area of shallower water (Bockelie 1978, p. 199, fig. 3A).

Siljan district, Sweden (loc. 4, text-fig. 1). Two or possibly three species of *Sphaeronites* occur at different horizons within the Siljan district. Only one, *S. variabilis* sp. nov., is reasonably common and confined to Dalarna, while the stratigraphical positions of the other two are better established elsewhere. *S. variabilis* occurs at Osmundsberget as the commonest species in a prominent cystoid bed about 10 cm thick and lying approximately 5 m below the top of the Fjäckå Shale within the Slandrom Limestone. It also occurs as scattered specimens through the lower Jonstorp Limestone and into the crinoidal calcarenite flank facies of the Boda Limestones up to about 24 m above the top of the Fjäckå Shale. In the southern section of Osmundsberget quarry, where the *S. variabilis* band was best exposed in 1974, Ordovician limestones occur at least to 78 m above the Fjäckå Shale so that *S. variabilis* is confined to the lower third or less of the Boda Limestone. At Skålberget, nearby, *S. variabilis* occurs from 5 to 36 m above the Fjäckå Shale and the Ordovician limestones are estimated to be 75 m thick above the Fjäckå Shale. While precise thicknesses may not be reliable as most beds thin rapidly away from Boda mound cores, it does seem reasonably established that *S. variabilis* occurs from just below the Fjäckå Shale up into the lower part of the Boda Limestone, but not to the top. This corresponds to a range from somewhere in the Pusgillian up to the Cautleyan or possibly low Rawtheyan, but certainly not into the

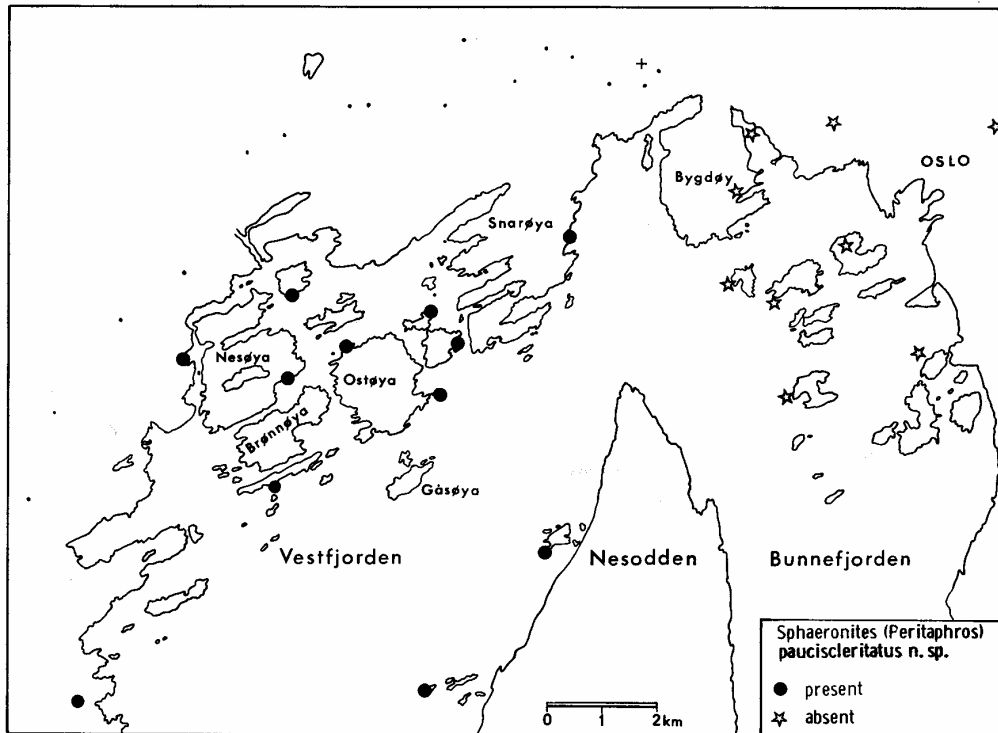

TEXT-FIG. 3. Map showing localities for *Sphaeronites (Peritaphros) pauciscleritatus* sp. nov. in the Oslo Region, Norway. Note its absence from the more north-easterly outcrops.

Hirnantian as previously suspected. *S. variabilis* is recorded from a number of other Boda carbonate mounds in Dalarna, but the precise range of the species is unknown at these localities.

Kinneulle, Västergötland, Sweden (loc. 5, text-fig. 1). In the quarries at Österplana on the east side of Kinneulle Mountain (and elsewhere around the Mountain) a section is exposed from the lower Red Orthoceras Limestone through the Grey Orthoceras Limestone into the upper Red Orthoceras Limestone (text-fig. 4A). *S. pomum* (Gyllenhaal) occurs in a discontinuous band at the junction between the Grey and upper Red limestones while *S. minor* sp. nov. occurs in a continuous band 16–20 cm lower down within the Grey Orthoceras Limestone and scattered specimens occur to at least 15 cm below this band. The Grey Orthoceras Limestone probably correlates with the upper Arenig or lowermost Llanvirn. Irrespective of precise age, *S. minor* is undoubtedly older than *S. pomum* and both species maintain their relative positions to within 2 cm all around Kinneulle Mountain.

Bödahamn, Öland, Sweden (loc. 6, text-fig. 1). *S. globulus* occurs in the Dalby Limestone north of the new harbour at Bödahamn. It ranges through perhaps 20 cm of limestone associated with *Caryocystites dubia* (Angelin), *Lophocystis granatum* (Wahlenberg), and *Echinosphaerites aurantium* (Gyllenhaal). The Dalby Limestone probably correlates with the middle Llandeilo to lowermost Caradoc.

Södra Möckleby, Öland, Sweden (loc. 7, text-fig. 1). At the top of the upper level of the huge quarry at Södra Möckleby two beds of *S. pomum* occur separating the lower and upper Asaphus Limestones (Moberg 1890). The upper *Sphaeronites* bed is up to 5 cm thick and crops out on the surface above the top of the quarry face (text-fig. 4B). The lower *Sphaeronites* bed is approximately 75 cm lower down and up to 20 cm thick. Both beds yield only *S. pomum* (we have found no *S. minor* outside Kinneulle), often weathered so as to reveal beautifully the details

of the surface and diplopores (e.g. Pl. 72, figs. 1, 2). The Asaphus Limestones correlate with the upper Arenig or lower Llanvirn, but the age of these *Sphaeronites* relative to those of *S. pomum* and *S. minor* at Kinnekulle cannot be determined exactly on present knowledge.

Estonia and Leningrad Province, U.S.S.R. (loc. 8, text-fig. 1). *S. globulus rossicus* has been named from Ordovician outcrops in the east Baltic by Hecker (1964, pl. 4, figs. 3, 4a, b). Prof. Hecker intends to describe this form together with another new species. As we have no specimens for comparison, we cannot relate them morphologically or stratigraphically to the other species considered here.

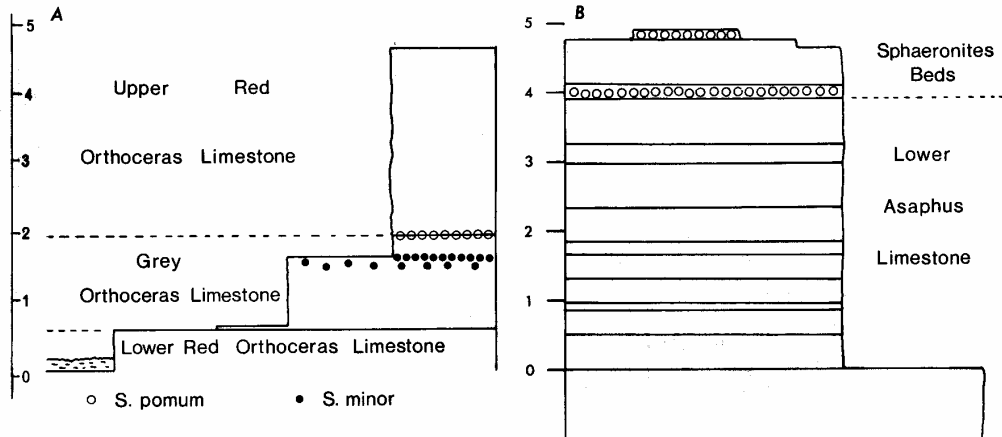

TEXT-FIG. 4. Sections at Österplana, Kinnekulle, Västergötland (A), and at Södra Möckleby, Öland (B), showing occurrences of *Sphaeronites* spp. At Österplana *S. (S.) pomum* occurs at the junction between the Grey and Red Orthoceras Limestone, with *S. (S.) minor* some 20 cm lower. At Södra Möckleby two beds with *S. (S.) pomum* occur at the top of the quarry section. No correlation is implied by the relative positions of the sections. Scales in m.

We consider the first occurrences of species to be more important in an evolutionary context than the total range. On this basis the species of *Sphaeronites* which we have studied evolved in the following order: *S. minor* preceded *S. pomum* in the upper Arenig or lower Llanvirn. *S. globulus* (upper Llandeilo-lower Caradoc) and *S. pauciscleritatus* (middle Caradoc) followed in the middle Ordovician, while *S. variabilis* (Pugillian-?Rawtheyan) followed by *S. litchi* and *S. insuliporus* (Cautleyan-Rawtheyan and Cautleyan, respectively) and finally *S. pyriformis* (Rawtheyan) came last in the Ashgill. This sequence differs slightly from that indicated previously (Paul 1972, 1973) in that *S. variabilis* is now known to occur below the Fjäckå Shale and not to extend up into the highest Boda Limestone. Previously it had been thought to occur only in the Boda Limestone and to range from the upper Ordovician into the lowermost Silurian (e.g. Regnéll 1945). This species fits better into the evolutionary trend in diplopore density as a low Ashgill rather than a high Ashgill form. In discussing all evolutionary trends, the above order of species is considered to reflect the actual course of evolution. However, we have relatively little information about *S. pyriformis*, so many comparisons between early and late species contrast *S. minor* with *S. litchi* as the latest species for which reasonable numerical data are available.

#### MORPHOLOGY, TERMINOLOGY, MEASUREMENTS

*Sphaeronites* was a directly attached diploporite cystoid with a cylindrical to spherical theca. A distinct attachment area is present on most specimens and the mouth and anus lie close together on

a raised oral platform. Between these larger orifices and to the left is a small circular gonopore, usually 0.5 mm in diameter. In *S. pauciscleritatus* a minute oval hydropore occurs just adoral to the gonopore.

The arrangement of thecal plates in *Sphaeronites* is not fixed, except in the oral area, and most species seem to have added plates during growth. In *S. pauciscleritatus* and *S. variabilis* the usual seven circum-oral (CO, plural COO) plates, found in all genera of Sphaeronitidae (Paul 1973, p. 12), occur but only the six larger circum-orals, which form the frame of the peristome, have been confirmed in other species. All plates bear numerous diplopores which are densely and evenly packed over the entire theca, except the attachment area and oral platform. In *S. pomum* and *S. pauciscleritatus* a narrow marginal band free of diplopores may occur on some thecal plates.

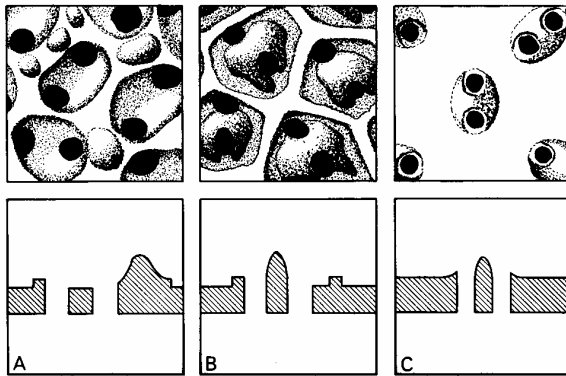

TEXT-FIG. 5. Typical diplopores of subgenera *Sphaeronites s.s.* (A), *Peritaphros* Paul (B), and *Ataphros* subgen. nov. (C).

Two types of diplopore have been used to recognize two subgenera (Paul 1973, pp. 20–21). In *Sphaeronites s.s.* there are sunken peripores and conspicuous tubercles or short spines developed on the peripore wall (Pl. 72, fig. 1; Pl. 73, fig. 6; text-fig. 5A), while in *Peritaphros* a large central tubercle develops and the peripore is reduced to a moat-like channel around the central tubercle (Pl. 73, fig. 7; text-fig. 5B). A third type of diplopore is now known to occur in the Sholeshook Limestone species *S. (Ataphros) insuliporus* subgen. et sp. nov., where only the central tubercle of *Peritaphros* remains and the peripore has become so reduced as to be absent altogether (Pl. 73, fig. 8; text-fig. 5C). So far *S. (A.) insuliporus* is the only known species of *Ataphros* and it is exceedingly rare.

The mouth of *Sphaeronites* lies within an oval or rounded peristome and was covered with six palatal plates in life. The anus opened through a polygonal periproct covered by a simple anal pyramid of five to seven anal plates which could open outwards but not inwards. Both orifices lie very close together on the oral platform and rarely exceed 3 mm in major dimension. Nearly always five ambulacra, each with one to three small ambulacral facets, are developed adjacent to the mouth on the oral platform. Four examples of *S. variabilis* are known in which ambulacrum III is undeveloped. Three ambulacral facets occur in ambulacrum II and III of the holotype of *S. pauciscleritatus*, necessitating a slight modification of the diagnosis of the genus *Sphaeronites* given by Paul (1973, p. 19). As with almost all Diploporita, the ambulacral appendages which articulated on these facets are never preserved.

Attachment was direct and the size and shape of the attachment area were largely controlled by the available substrate. *Sphaeronites* only exceedingly rarely developed an aboral stem-like extension to the theca. Of the thousands of specimens we have seen, only one or two show such a feature.

Within the theca an internal hollow spine has been detected in *S. variabilis* (text-fig. 6), *S. litchi*, *S. globulus* and *S. pauciscleritatus*, all species of the subgenus *Peritaphros*. It is absent in all examples of *Sphaeronites s.s.* that have been sectioned, but may well have been characteristic of *Peritaphros*.

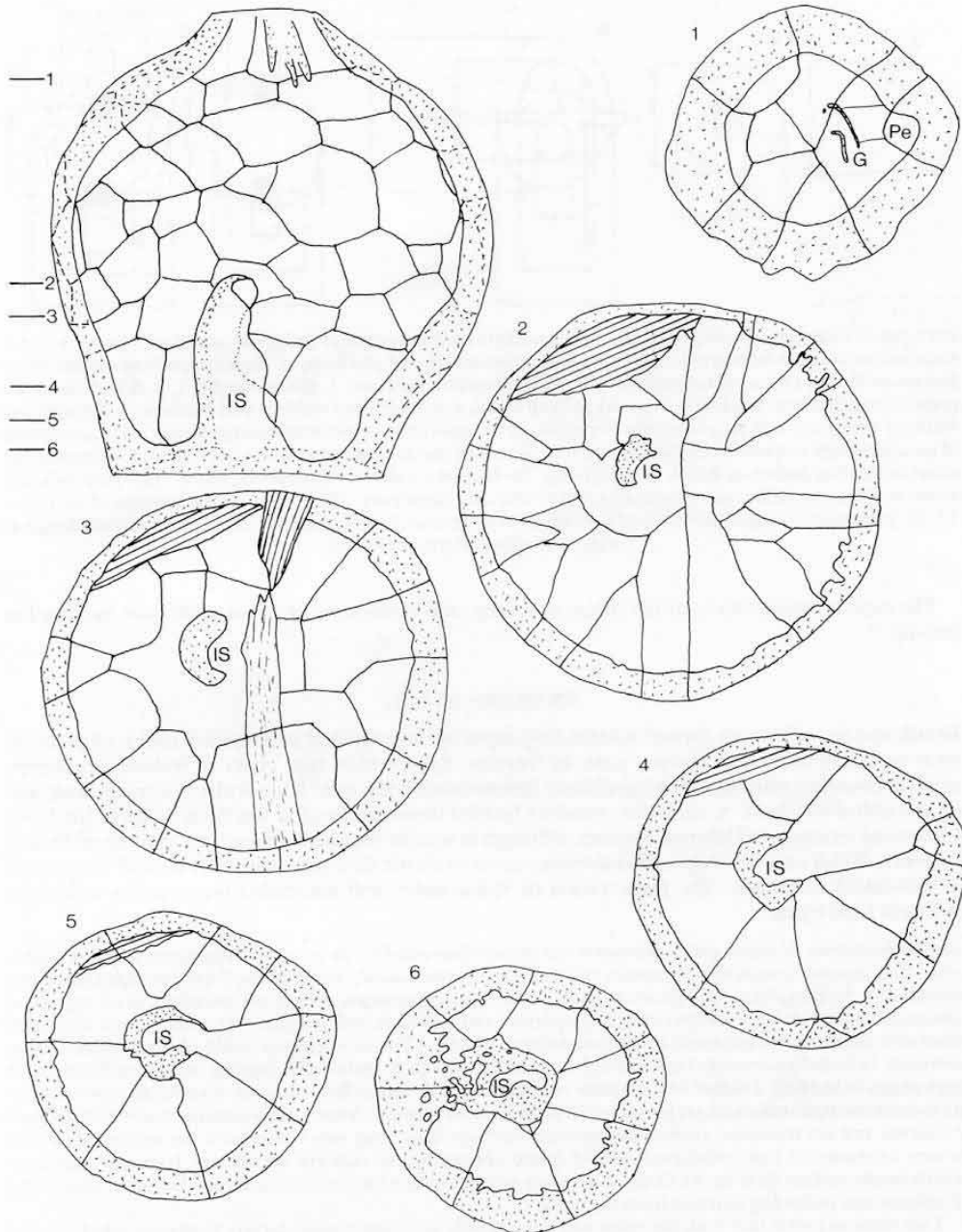

TEXT-FIG. 6. Reconstruction of half a serially sectioned specimen of *Sphaeronites (Peritaphros) variabilis* sp. nov. (top left) to show internal spine (IS). 1-6, six transverse sections to show gonoduct (G), periproct (Pe) and internal spine. Positions of sections indicated at top left. Stereom stippled, calcite fill white, sediment ruled. Broken lines in section 3 indicate damage during cutting. Approximately  $\times 2.5$ .

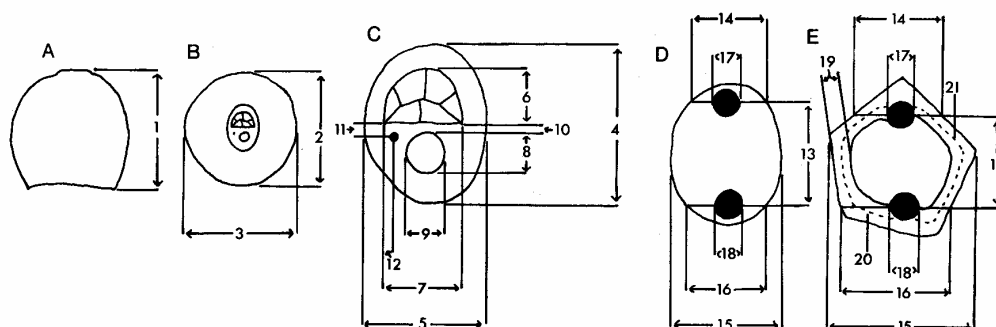

TEXT-FIG. 7. Diagram showing principal measurements used in computer programs and descriptions. A and B, measurements taken from whole thecae; C, measurements of oral platform; D, measurements of dipopores of *Sphaeronites s.s.*; and E, of subgenus *Peritaphros*. Measurements are: 1, thecal height; 2, 3, thecal diameters (mean thecal diameter is taken as the average of all three); 4, 5, length and width of oral platform; 6, 7, length and width of peristome; 8, 9, two diameters of periproct; 10, separation of peristome and periproct; 11, 12, positions of gonopore with respect to peristome (gonopore diameter was also recorded where possible); 13, perpendicular canal separation (taken as length of dipopore); 14–16, three widths of dipopores, one at each perpendicular canal and the maximum width perpendicular to the axis (dipopore width taken as the average of all three); 17, 18, perpendicular canal diameters; 19, width of peripore canals in *Peritaphros*; 20, 21, approximate length of peripore canals in *Peritaphros* spp.

The measurements made of the theca, oral area, and dipopores of *Sphaeronites* are indicated in text-fig. 7.

#### PRESERVATION

British and Scandinavian *Sphaeronites* mostly occur in three types of sedimentary rocks, all of which were probably formed in shallow seas. In Sweden, *Sphaeronites* spp. occur in bedded limestones, often in countless numbers forming distinct *Sphaeronites* beds, as at Kinnekulle, Västergötland, and on the island of Öland. *S. variabilis* occurs in bedded limestones and in the flank facies of the Boda Limestone mounds, in Dalarna, Sweden, although in smaller numbers. In contrast to these carbonate deposits, Welsh and Norwegian *Sphaeronites* occur in clastic sediments with only a small proportion of associated carbonate. The preservation of *Sphaeronites* and associated fauna varies with these different rock types.

**Bedded limestones.** *S. minor* and *S. pomum* occur in countless numbers in two distinct horizons which probably extend all around Kinnekulle Mountain and are almost continuously exposed for 2 km between Österplana church and Sveningstorp. All specimens lack ambulacral appendages, which are unknown in all species of *Sphaeronites* (and all but a few species of Diploporita), and most lack oral and anal cover plates. Tests are largely filled with sediment and randomly orientated within the beds. A few show geopetal infills of sparry calcite above sediment. In both *Sphaeronites* beds, examples can be found with geopetal infills dipping in random directions at high angles to bedding. Further field evidence of reworking is shown by the orthoconic nautiloids, most of which have excentric siphuncles and are preserved with the siphuncle below. Many orthocones have only half the shell preserved and are truncated against discontinuity surfaces, which are very common in the section. However, several examples of half orthocones can be found convex up, or concave up but not truncated against a discontinuity surface (text-fig. 8). Orthocones show strong preferred orientation at several horizons, with V and T orientations indicating currents from the north.

Thin sections reveal that both the *minor* and *pomum* beds at Österplana are largely biomicrite which may be matrix or grain supported. The commonest fossil fragments are of echinoderms and trilobites, but ostracodes, brachiopods, and gastropods occur as well. Sediment fills within cystoids are often of fine micrite with very few small fossil fragments, but more complex fillings can be seen, with fine micrite followed by sparry calcite, or



occasionally fine micrite followed by grain-supported biomicrite with common sparite replacements and cavity fills. Where *Sphaeronites* are preserved epifaunal on other *Sphaeronites*, no interlocking of stereom occurs and all evidence suggests that substrate specimens were dead and at least partly sediment filled before attachment of epifaunal specimens. One sectioned specimen shows geopetal fills parallel to the attachment surface and has excellently preserved surface topography, suggesting that it was buried *in situ*, but with so many randomly orientated tests, chance alone would account for a single example preserved the right way up. The evidence of winnowing, reworking, and current activity suggests very slow net accumulation of sediment which has been further reduced by compaction and pressure solution. Some of the discontinuity surfaces represent contemporaneous hardgrounds, or at least firm grounds, and very rarely crinoid attachment discs encrust directly on to the surfaces, but no other hardground indicators have been seen. The *Sphaeronites* beds seem to represent lag deposits with the distinct possibility that later individuals were epifaunal on rolled and reworked earlier individuals.

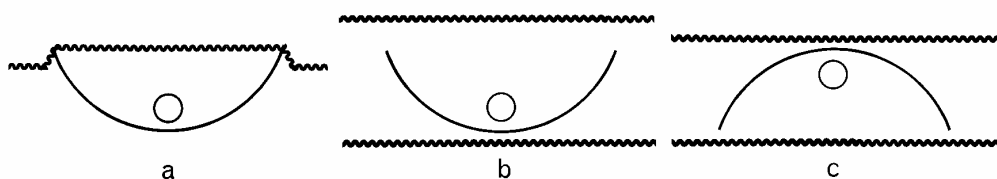

TEXT-FIG. 8. Diagram showing relationship of orthocones to discontinuity surfaces in the *Orthoceras* Limestone at Österplana, Kinnekulle, Västergötland, Sweden. Most orthocones are preserved with the siphuncle below and the upper edges truncated against discontinuity surfaces (a). A few show the relationships in (b) and (c) demonstrating that the incompleteness of the orthocones is not entirely due to the discontinuity surfaces. In (b) the orthocone was only partly buried and the upper part decayed before renewed sedimentation. In (c) the resulting half shell was overturned before final burial. This preservation implies very slow sedimentation rates and the section has since been further reduced by pressure solution along the frequent discontinuity surfaces. We believe the discontinuity surfaces are partly original, but have been enhanced by pressure solution, as is clearly the case in (a). All three drawn from field sketches.

Other echinoderms include fairly common *Bolboporites*, and a cheirocrinid rhombiferan with disjunct pectinirhombs, with a hybocrinid crinoid and *Rhipidocystis* which are rarer. All of these are represented by isolated plates only. Other fauna, like the other echinoderms, is sparse except for orthocones. Trilobites, gastropods, brachiopods, and ostracodes are evident. The slow accumulation of sediment implies that these two *Sphaeronites* species were less abundant when alive than they are now. Nevertheless the relative rarity of other fauna suggests they were genuinely very common and gregarious.

At Södra Möckleby, on Öland, *S. pomum* occurs alone in two similar *Sphaeronites* beds about 60 cm apart. Here again orthocones are very common and show strong preferred orientation indicating currents from the north. In section most orthocones are complete and show randomly positioned siphuncles. Only a few examples are truncated by discontinuity surfaces, which are common in this section too. The upper surfaces of both *Sphaeronites* horizons have rare crinoid attachment discs on them, again suggesting at least firm ground development. The overlying Viruan (middle Ordovician) is close to the top of the section, perhaps only 30 cm above the upper *Sphaeronites* band, which suggests that both *S. pomum* horizons in Öland may be younger than the bed at Kinnekulle.

Thin sections reveal that the lower *Sphaeronites* bed is a grain-supported biosparite with a little, possibly original, micrite, while the upper horizon is grain- or matrix-supported biomicrite very much like the beds at Kinnekulle. Spar-filled *Sphaeronites* are more common in the lower bed which is thicker and has cystoids with better preserved surface details. Specimens in the upper unit are often incomplete, abraded, or otherwise damaged. Epifaunal *Sphaeronites* are more common in the upper bed and, as at Kinnekulle, they apparently grew on dead, rolled, and sediment-filled substrate specimens. In one example, the stereom of the epifaunal specimen partly penetrated two of fourteen diplopore canals in the section, the other twelve being sediment filled. No interpenetration of stereom has been seen.

Associated echinoderms include a hemicosmitid and a cheirocrinid Rhombifera, crinoid stems, and *Bolboporites*. Other fauna include orthocones, trilobites, brachiopods, and ostracodes. Crinoid columnals and

brachials are more common and varied than at Kinnekulle, but otherwise the fauna is similar. Again net sediment accumulation was probably slow, but the *Sphaeronites* were genuinely very common.

*S. globulus* occurs with three other cystoid species in the Dalby Limestone at Bödahamn, Öland. Both the echinoderm and other fauna are more abundant and varied than in either of the lower Ordovician localities described above. Vertical sections cannot be seen as all the outcrop is on the foreshore. *S. globulus* and *Echinosphaerites aurantium* are usually spar filled, while *Lophocystis granatum* and *Caryocystites dubia* are more commonly sediment filled. Apart from these complete cystoids, *Bolboporites*, a cheirocrinid, and various crinoids are represented and the non-echinoderm fauna includes trilobites, brachiopods (articulates and rare inarticulates), bryozoans, gastropods, rare bivalves, ostracodes, conulariids, and ortho- and gyroconic cephalopods.

Thin sections show the Dalby Limestone to be a grain-supported biomicrite with common sparite-filled voids varying to grain- or matrix-supported biomicrite. The rare *S. globulus* with sediment fill have much finer biomicrite fill than the surrounding matrix. Sediment fills in other cystoids show several stages of development, including matrix-supported fine-grained biomicrite and grain-supported coarser biomicrite. The exact sequence is not clear, but occasionally fills show 'graded bedding' of fossil fragments within a micrite matrix. As elsewhere, many cystoids have suffered pressure solution and have lost their surface ornament above and below, but may retain it in a peripheral band. Again sediment accumulation seems to have been intermittent and slow with cystoids common and gregarious, but the fauna is no longer dominated by a single species.

The only other '*Sphaeronites* bed' we have examined is a discontinuous bed which is now apparently quarried away, but which was formerly well exposed on the south side of the uppermost level of the quarry at Osmundsberget, Dalarna, Sweden. Here *S. variabilis*, *Heliocrinites ovalis*, and possibly a *Caryocystites* species occurred in profusion in 1974.

Thin sections reveal a matrix-supported biomicrite with some clay admixture often concentrated in discontinuity surfaces which truncate cystoid tests and crinoid columnals. Cystoids are partly filled with sediment and partly spar filled. Geopetal surfaces parallel the bedding, and evidence for current activity and reworking is absent. Some sediment fills within cystoids are graded and show multiphase filling. Associated fauna is dominated by echinoderm debris.

All these bedded limestone occurrences of *Sphaeronites* have some features in common. They are in markedly bioclastic sediments, usually with a micrite matrix. The *Sphaeronites* are common to abundant and were apparently gregarious in life. Two slightly different modes of preservation occur from which we infer slightly different preservational histories. All specimens were epifaunal when alive; most became detached at, or soon after, death and all lost the ambulacral appendages. Where the oral and anal cover plates were also lost or where the test itself was damaged, sediment fill was coarse-grained, often grain-supported, and nearly or totally complete. Where the cover plates were retained, sediment fill was fine and often very incomplete, being followed by spar fill growing in optical continuity with test plates and forming so-called 'crystal apples'. Both types may have been reworked, but generally where contemporaneous reworking occurred cover plates were lost and spar-filled specimens are less common. The conclusion that cover plates were usually lost by reworking seems inescapable. Finally, most specimens have suffered some pressure solution and secondary spar infilling of the organic spaces in the stereom during diagenesis.

*Flank facies of carbonate mud mounds.* Above the Fjäckå Shale in Dalarna, *S. variabilis* occurs in the equivalents of the Lower Jonstorp Formation beneath the Boda Limestone and also in the flank facies through the lower half or so of the Boda Carbonate mounds. The Lower Jonstorp at Skålberget consists of thinly bedded limestones with a greater or lesser clastic content. In thin section, lithologies vary from muddy, matrix-supported biomicrite to grain-supported and pressure-welded echinoderm biosparites with clastic accumulations in solution-compaction horizons. Small angular quartz grains are not uncommon in the clastic concentrations. Sutured contacts between echinoderm grains abound in the echinoderm debris limestones. At Osmundsberget the Lower Jonstorp is very similar and at both localities the alternations of clastic rich and echinoderm-rich limestones strongly resemble the flank facies of the Boda mounds except that they lack original dip. The flank facies consist of thin (1–5 cm) echinoderm debris limestones which alternate with reddish-brown or green shales. *S. variabilis* occurs in both the limestones and the shales. The specimens are randomly orientated but retain the oral and anal cover plates and are hence largely spar filled. *S. variabilis* accompanies a rich cystoid fauna including *Caryocystites ovalis* (Angelin), *Heliocrinites stellatus* Regnéll, *Eucystis angelini* Regnéll, *E. raripunctata* (Angelin), *E. quadrangularis* Regnéll, and *Haplosphaeronis oblonga* (Angelin). The accompanying non-cystoid fauna is also abundant and includes brachiopods, trilobites, bryozoans, occasional corals and gastropods, ostracodes, crinoids, and calcareous algae at some horizons. Most cystoids have complete tests although the *Eucystis* spp. characteristically have lost their cover plates. All these species are directly attached

forms and lived on the flanks of the mounds. We suspect that crinoid meadows occurred higher up the mounds and, on death, contributed to the flank limestones, possibly following storms. Wherever and whenever suitable substrata stabilized the cystoids colonized them. On death of the cystoids, which may have been caused by sudden influxes of mud that now forms the shale horizons, the cystoids were disturbed and probably rolled downslope slightly, but were otherwise undamaged. Geopetal infills indicate original dips on the flank facies of up to 20° or more. Diagenetic changes again appear to be limited to secondary infilling with spar and some pressure solution, but bitumen-impregnated specimens occur rarely at Osmundsberget and large cubes of secondary pyrite occur in some flank limestones.

Although *S. variabilis* occurs in the flank facies of the Boda Limestone, it appears first in bedded limestones. It occurs through several metres of the Lower Jonstorp Formation before making its appearance as isolated specimens or at most clusters of several tens of specimens in the flank facies. *Haplosphaeronis* and *Eucystis* occur in thousands in some flank deposits and it is reasonable to infer that even *S. variabilis* was not primarily associated with bioherms. A single example of *S. globulus* has been collected from the flank facies of the Kullberg Limestone mound at the type locality, Kullberg. Again it occurred in a *Haplosphaeronis* bed with thousands of specimens, but no other *Sphaeronites* is known associated with carbonate mound structures.

*Clastic sediments.* *S. pauciscleritatus* occurs in a fine-grained clastic sediment with limestone nodules in the middle of Stage 4b $\beta$  of the Oslo Region, west of Oslo. Oral and anal cover plates are preserved in some individuals which tend to be largely calcite filled. Other fills include a fine-grained argillaceous micrite and 'coal blende' (asphalt), as a dark crystalline filling. A small proportion of angular silt-grade quartz is present plus some finely divided pyrite. The rock is not very fossiliferous in thin section, but some rare trilobite and echinoderm stem fragments occur. In the rock orthid brachiopods, trilobites (*Chasmops*), ostracodes, and bryozoans, including *Diplotrypa*, have been found. Locally, large, loose thecal plates of a cheirocrinid cystoid occur. The sediment is usually full of *Chondrites* burrows, a situation commonly found in the fine grained sediments of the Oslo Region. Most of the material of *S. pauciscleritatus* seems to be randomly distributed in the sediments (one to three specimens per square metre). None of the specimens was still attached, but the shape of the attachment area suggests that some of them may have been epifaunal on orthoconic cephalopods, and later became detached. The presence of oral and anal cover plates and the size range (20–50 mm diameter) of *S. pauciscleritatus* suggest that the individuals were not transported very far and that final burial occurred relatively soon after death. *S. pauciscleritatus* only occurs in a restricted area which correlates with the occurrence of fine quartz. It may well have been associated with local N.–S. trending topographic highs in the Oslo Basin (Bockelie 1978).

*S. litchi* and *S. insuliporus* occur in the Sholeshook Limestone in South Wales. At Sholeshook, the Sholeshook Limestone is about 50 m thick, although the top and bottom cannot be seen. The lower part consists of muddy siltstone with perhaps as much as 20% angular silt-grade quartz, which alternates with fine argillaceous limestones in which the quartz content is reduced. Ferroan calcite occurs as fine crystals and fills veinlets. All indications are that it is secondary, and that when deposited the Sholeshook Limestone contained very little carbonate other than fossil fragments. Passing up the section, the grain size of the quartz increases, together with fossil content and pyrite. Pyritized echinoderms are not uncommon in the upper part of the section. The pyritization is a very early diagenetic phenomenon and tends to fill the organic spaces in the stereom meshwork of the inner portion of the plates only. The detailed structure of the stereom is revealed under suitable weathering (Paul 1971, pp. 9–11). Diagenesis which affects only the inner portion of thecal plates is not uncommon in cystoids. In general, it is confined to very early effects in complete thecae. Quite possibly decay of the soft tissue within a complete theca created a different chemical environment which triggered these diagenetic effects. Recent echinoids from Florida show similar post-mortem effects including growths of calcite crystals on the inner surface of the test (but nowhere else), which perhaps formed within a week of death.

In the upper Sholeshook Limestone, mica and small rock fragments are found above about 30 m in the section and the rock becomes a subgraywacke. Irregular burrows, probably *Chondrites*, occur throughout the section and are indicated by a darker filling than the surrounding rock. Associated cystoid fauna is abundant and varied. *Haplosphaeronis multifida* dominates, accounting for perhaps half the known specimens, but at least a dozen other species occur. Non-cystoid fauna is equally rich. Price (1973) records forty-one species of trilobites. Brachiopods, bryozoans, corals, ostracodes, cephalopods, and conulariids make up the rest of the fauna.

Most of the *Sphaeronites* specimens are randomly orientated and sediment filled. However, some are calcite filled and the cover plates are preserved on at least one example we have collected (Pl. 72, fig. 4). Reworking has occurred in the upper part of the Sholeshook Limestone. Paul (1973, pl. 10, fig. 1) illustrates one specimen of *H. multifida* which was reworked, rolled, and abraded, after initial burial and complete filling of the test with a little sediment and then sparry calcite. Laterally, the thecal plates are entirely worn away, exposing the calcite

fill within, and the specimen was redeposited as a small pebble. Much of the cystoid fauna in the upper Sholeshook Limestone may have undergone a similar two-stage burial history, with initial burial *in situ* followed by exhumation and redeposition nearby. Although approaching a graywacke, the Sholeshook Limestone shows no features of turbidite deposition.

North of Bala, North Wales, *S. pyriformis* occurs in the Rhiwlas Limestone which varies from a grain-supported clastic biomicrite to a muddy limestone with small strings of fossil debris. Current activity is evident and ferroan calcite occurs patchily through the rock and as overgrowths on echinoderm ossicles. Pressure welding is obvious in the grain-supported microfacies. A little angular silt-grade quartz occurs.

*S. pyriformis* is always sediment filled, the cover plates are unknown, and it occurs with a rich fauna of echinoderms and other fossils. At least ten other species of cystoids occur in the Rhiwlas Limestone, and Whittington (1968, p. 119) records twenty-nine species of trilobites. *S. pyriformis* is always small (10–15 mm in major dimension) and, since it occurs with large specimens of *Archeogocystis* and *Heliocrinites*, its small size is probably original and not due to preservational selection. *S. pyriformis* may well have been a small species. It is also possible that it may represent the early growth stages of *S. litchi*, a single specimen of which is known from the Rhiwlas Limestone. Pyrite occurs patchily and is a much later diagenetic effect than at Sholeshook. In the Rhiwlas Limestone pyrite occurs as irregular concentrations and cubes which cut across fossil and sediment grains in an irregular manner.

To summarize, *Sphaeronites* found in clastic sediments are not preserved *in situ*, but probably have not been transported very far. The presence or absence of oral and anal cover plates may be an indication as to either how rapidly the individuals were buried after death (i.e. the rate of sedimentation) or of the amount of transport. Both species of *Sphaeronites s.s.*, *S. (S.) minor* and *S. (S.) pomum*, rarely have the cover plates preserved and occur in sediments which on other evidence appear to have accumulated very slowly, whereas cover plates are commonly present on all the species of *Peritaphros*. *S. pyriformis* seems to have been more disturbed than other species. In Wales, *Sphaeronites* localities lie towards the edge of the shelf in relatively deep water compared with many Scandinavian localities. Associated cystoids can be divided into two groups. Directly attached forms with exothecal pore structures are usually preserved as complete or partial thecae and probably lived in association with *Sphaeronites*. They were all better adapted to live in water with suspended sediment. The other group are all free-living or attached rhombiferans with stems and endothecal pore structures, which are preserved as isolated plates in most cases. Endothecal pore structures would become clogged in sediment-laden water, which suggests that these cystoids lived further from the sites of deposition and not in association with *Sphaeronites*, an idea confirmed by their fragmentary remains.

#### PALAEOECOLOGY

*Sphaeronites* were directly attached by the base of the theca and a more or less definite attachment area can be recognized in most specimens. Nevertheless, exceedingly few specimens are preserved attached to their substrates. The relatively rare instances which do occur invariably involve a *Sphaeronites* epifaunal on another echinoderm, most often another *Sphaeronites*. Despite the rarity of attached specimens, attachment areas are frequently undamaged and we think that *Sphaeronites* attachment may have been effected, in life, by the epidermis rather than by direct cementation of the test to the substrate. Thin sections of *Sphaeronites* epifaunal on other echinoderms show no interpenetration of stereom structure, although the stereom of the epifaunal example may penetrate diplopore canals. On death, decay of the epidermis would allow detachment without damage to the attachment area.

*Sphaeronites* were filter-feeders and apparently colonized any substrate that was sufficiently stable for them to grow on. Competition for food with other filter-feeding organisms does not seem to have been a serious problem to judge from the rich brachiopod faunas which accompany most *Sphaeronites* species. All *Sphaeronites* were probably low level filter-feeders in life, and show little, if any, evidence of thecal elongation or development of an aboral stem-like projection which would have raised the food-gathering organs off the substrate.

*Sphaeronites* were apparently gregarious, a mode of life which increases the chances of successful breeding in all sessile benthos. Earlier species (*S. pomum* and *S. minor*) may have been more strongly gregarious than later species and occurred in millions, to judge by the *Sphaeronites* beds in Kinnekulle and on Öland. Later forms (*S. litchi*, *S. variabilis*, etc.) may not have been so strongly

gregarious since they occur in less dense populations associated with a greater variety of other echinoderms. Indeed, an overall change occurs throughout the Ordovician from low diversity and high abundance in the Arenig species to low abundance and high diversity in the Ashgill forms. Thus it seems possible that competition among echinoderms increased significantly as more species became adapted to the same or similar environments.

#### FUNCTIONAL MORPHOLOGY

Although most palaeontologists agree that fossils should be regarded as once-living things and many accept a Darwinian view of evolution in which competition and selection play important roles, surprisingly few systematic accounts of the vital functions of fossils or functional interpretations of evolutionary trends have been published. In this section we review information about how *Sphaeronites* performed the vital functions necessary for life, such as feeding, breathing, protection, etc. Where data are adequate, we also consider how the performance of these functions changed during growth and evolution. In appropriate cases we erect a paradigm for the function and then compare the actual morphology with this ideal.

##### *Protection*

In *Sphaeronites*, as in other cystoids, protection of the soft anatomy was provided by the theca which forms a protective envelope. The paradigm for a protective envelope would be as strong as possible, completely enclose the vital organs, and lack any apertures. However, such a paradigm would isolate the internal organs from the surrounding sea water which contains all the food and oxygen necessary for life, and might pose problems in growth. The paradigm for any one function should contain a qualification that it does not seriously interfere with any other vital function. In *Sphaeronites* the conflicting requirements of protection on the one hand, and of feeding and respiration on the other, are overcome by special ambulacral orifices at the corners of the peristome for the entry of food particles and by the diplopores for respiration. Requirements of protection were met during growth by the theca being composed of tessellated plates, which themselves grew in such a way that no spaces developed between them and which increased in thickness as the theca enlarged. We first compare the construction of the theca in *Sphaeronites* with the paradigm of a protective envelope and then consider the compromises between the conflicting requirements of protection, feeding, respiration, and growth.

As in most other echinoderms, the theca of *Sphaeronites* is composed of individual plates which were an intimate meshwork of calcite, collagen fibres, and soft tissue in life (see Moss and Meehan 1967, for an account of the structure in a living echinoid). As with all organic skeletons, the plates are made of a composite material which, in this case, combines the strength of calcite with the elasticity of collagen and soft tissue, to overcome the brittle nature of the strong component, calcite. A measure of the success of this composite can be seen in the fact that although each plate is a single crystal of calcite, when damaged in life plates do not fracture along calcite cleavage planes. In general, the shape and arrangement of the strong component controls the distribution of strength in a composite material (Wainwright *et al.* 1976, p. 298, principle 4a) so that the strength of a granular composite is largely isotropic while that of fibrous or laminar composites is markedly anisotropic. In all echinoderms the arrangement of the stereom meshwork gives a clue to the distribution of strength within a plate, or the test as a whole. In *Sphaeronites*, as in most cystoids and echinoids where details of the plate structure are known, each plate consists of an inner laminar layer, outer fibrous layer, and the external surface tends to be granular (Paul 1971, 1977). Fibres in the fibrous layer are made of calcite and collagen and lie perpendicular to plate sutures (Paul 1971; Moss and Meehan 1967). The sheets of the laminar layer are parallel to the test surface. Under stress the test is much stronger parallel to the fibres and in the planes of the laminar sheets. There is less chance of the plates dislocating along sutures in life and this type of damage does not normally occur in living echinoderms. Thus, in general, echinoderm plates have less resistance to stresses operating perpendicular to their test surface, but are highly resistant to any stresses which lie parallel to the

plate surfaces. When assembled to form a test like that of *Sphaeronites*, stresses are predominantly transmitted within the plates, not perpendicular to their surfaces. The anisotropy of strength in the plates of *Sphaeronites* is precisely that which would be needed to accommodate stresses induced by wave or current action or the activities of predators.

The theca of *Sphaeronites* is frequently spherical, an ideal shape which encloses the maximum volume with the minimum constructional material. Juveniles and other examples with relatively large attachment areas may depart from the ideal sphere and have cylindrical or fusiform thecae. The theca is composed of randomly arranged plates, the thickness of which is fairly constant for a given species. Plates are thickened around the edge of the attachment area and at the oral pole where they form a raised oral platform surrounding the peristome and periproct. In some specimens of *S. (S.) minor* and *S. (S.) pomum* plates forming the attachment area itself are less than half the normal thickness, but presumably the hard substrate provided adequate protection in life. When detached from the substrate these species at least would have been relatively vulnerable. In a theca of uniform thickness and homogeneous construction, strength is inversely proportional to the radius of curvature. In a non-spherical theca where the radius of curvature is smallest one would expect the theca to be thickest if strength is to be maintained. In *Sphaeronites*, and many other directly attached cystoids, the thickest plating occurs at the sharp angle between the attachment area and the sides of the theca as predicted by strength requirements (text-fig. 9). Not only is the theca not of uniform thickness but it is

TEXT-FIG. 9. Camera lucida drawing of the thickness of the thecal wall in *Sphaeronites (Sphaeronites) minor* sp. nov. to show thin wall over the attachment surface (below) and maximum thickness at the angle between the attachment surface and the lateral wall. Thecal wall stippled. Note pressure solution of test.

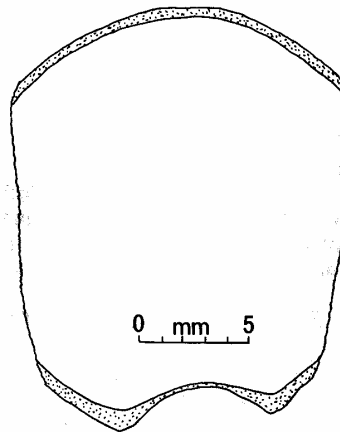

not of homogeneous construction either. Moss and Meehan (1967) have shown that, contrary to popular opinion, the plate sutures are not lines of weakness in a living echinoid and this was probably true of *Sphaeronites* as well.

Thecal plates vary in thickness from about 0.25 mm up to 2.5 mm, fit together without any gaps except for the special orifices necessary for feeding, etc., and lack weak spots. They completely enclose the vital organs and compare well with the paradigm of a protective envelope. During growth, plates were added in most species of *Sphaeronites*. Secondary plates start as small triangular plates at the triple junctions of primary plate sutures. In *S. (S.) pomum* and *S. (P.) globulus*, for which the best data were available (text-fig. 10), plate thickness increases slightly with growth. The ratio of plate thickness to maximum plate diameter and of plate thickness to maximum thecal diameter are measures of the strength of plates and thecae, respectively. Table 1 records maximum plate thickness, diameter of plates, and maximum thecal diameter for various species of *Sphaeronites*. A progression in both plate thickness and size occurs from earlier to later species, but the ratio of these remains fairly

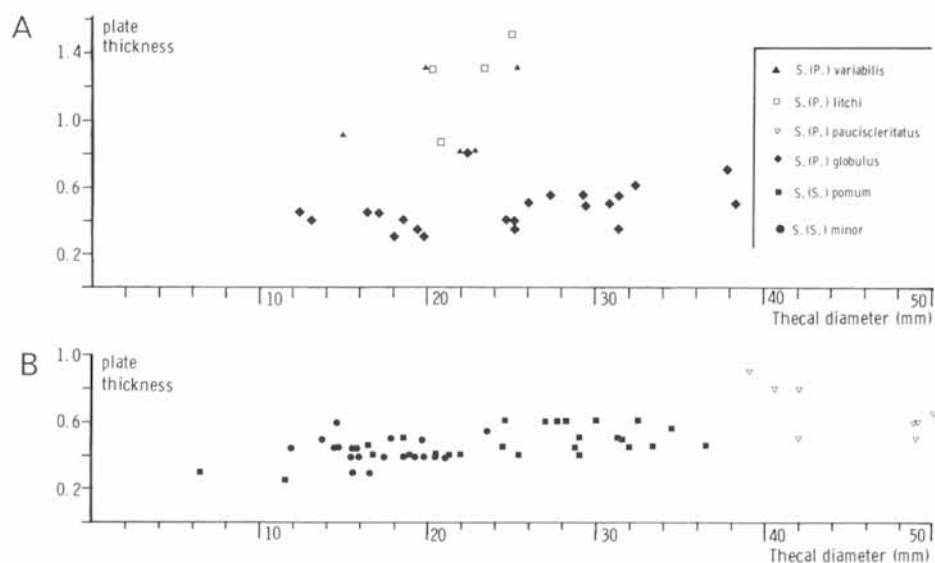

TEXT-FIG. 10. A, B. Graphs showing the relationship between plate thickness and mean thecal diameter in *Sphaeronites s.s.* and *Peritaphros* Paul.

TABLE 1. Maximum measurements of plates and thecae in *Sphaeronites*

Species	Age	Maximum measurement (mm)		
		*Plate thickness	Plate diameter	Thecal diameter
<i>S. minor</i>	U. Arenig	0.6	3.24	23.1
<i>S. pomum</i>	U. Arenig	0.6	4.06	36.5
<i>S. globulus</i>	U. Llandeilo	0.8	4.17	37.9
<i>S. pauciscleritatus</i>	Caradoc	1.0		50.0
<i>S. variabilis</i>	U. Caradoc-	1.3	7.83	26.5
	L. Ashgill			
<i>S. litchi</i>	L.-M. Ashgill	1.5	7.4	39.1

\* Measured near the middle of the sides of the theca and therefore not including the thickest parts at the edges of the attachment areas.

constant. The ratio of plate thickness to thecal diameter increases with time and the later species would seem to have had stronger thecae than early species.

The peristome and periproct are relatively large orifices but were protected by cover plates in life. Food entered the peristome through five small ambulacral orifices (text-fig. 13) at the corners of the peristome. There is no evidence that the palatal plates (oral cover plates) were able to open in life. The periproct was covered by an anal pyramid which could open outwards but not inwards, and acted as a one-way valve allowing egress but not entry. It was presumably closed most of the time. Cover plates (palatals and anals) effectively complete the protection afforded by the theca.

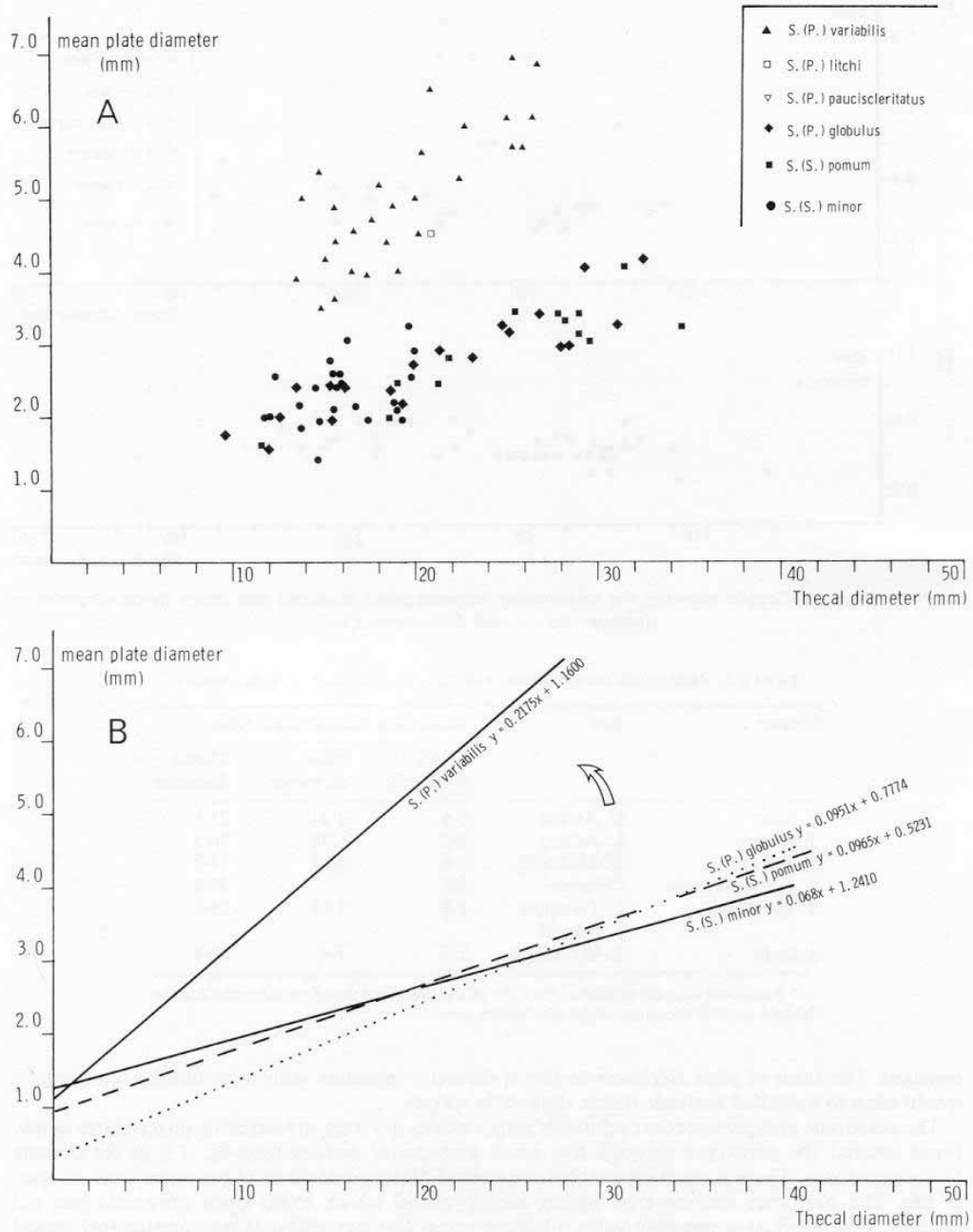

TEXT-FIG. 11. Graphs showing the relationship between mean plate diameter and mean thecal diameter. A, scatter diagram; B, best fit lines (arrow indicates evolutionary trend).



The diplopores were the main respiratory organs (see below) and were covered in life by soft tissue. They were not protected themselves by spines as are the tube feet of modern echinoids, and were presumably subject to predation. We do not think that they were extensible. The soft tissue cover may have been partly protected by the peripheral tubercles of *S. (S.) minor* and *S. (S.) pomum*, but later species lack these features.

Average plate diameter has been estimated by measuring two diameters in up to twenty plates per theca in each species. From these figures we have calculated an estimated plate number per theca (a parameter which is hardly ever directly measurable) by calculating the mean area of thecal plates and the estimated area of the entire theca. Both average plate diameter and estimated plate number increase with growth in all species for which quantitative information is available (text-figs. 11 and 12) as one would expect. However, the rates of increase change during evolution. Low and middle Ordovician species have a relatively high rate of increase in plate numbers, but a low rate of increase in plate size. *S. (P.) variabilis*, the only upper Ordovician species with reasonable data, has a low rate of increase in plate numbers, but a rapid increase in the size of plates. This, coupled with qualitative observations in *S. (P.) pauciscleritatus* and *S. (P.) litchi*, implies that the introduction of new plates played a more important role in thecal growth of low and middle Ordovician species, whereas growth of existing plates was more important in later species. The pattern of thecal growth seems to have simplified during evolution.

#### Feeding

*Sphaeronites* was a directly attached cystoid. It must, therefore, have been a filter-feeder which trapped food particles using its ambulacral appendages. The latter are never preserved and so their efficiency cannot be compared with any paradigm. Indirect evidence (outlined below) suggests that the appendages were simple unbranched structures with a length approximately equal to thecal diameter. Except in rare examples of *S. (P.) variabilis* with four, five ambulacra occur in all specimens of *Sphaeronites*. Each ambulacrum had one to three facets directly adjacent to the mouth on the border of the oral platform (text-fig. 13). Feeding and respiration rates are closely linked. All species of *Sphaeronites* had approximately the same respiration rates for any given size (text-fig. 20). Changes in respiration during growth were presumably matched by an increase in the length of the ambulacral appendages or by the addition of new appendages. However, as ambulacral facets are only rarely preserved, very little is known about the latter. Thus no direct evidence of changes in feeding during ontogeny or evolution have been recognized.

Something about the nature of the food, assimilation rates, and changes in feeding during growth and evolution can be inferred from the morphology of the oral area. Food particles entered the theca through minute ambulacral orifices at the corners of the peristome and continued to the edge of the mouth along narrow food grooves beneath the palatal plates. The diameters of the ambulacral orifices and food grooves put a maximum limit of about 0.1 mm diameter on food particle size. Particles larger than this would not have been able to enter the theca. The anus, on the other hand, is a relatively large opening of less than 1 mm diameter only in the smallest examples and may reach as much as 3 mm mean diameter in *S. (P.) litchi*. It seems reasonable to infer that the assimilation rate was relatively low and the faeces bulky in *Sphaeronites*. In other words, a large proportion of the food trapped by the ambulacral appendages was not digested completely, the particles were packed together in the gut, and voided as relatively bulky pellets, up to twenty or thirty times the diameter of the ingested food particles, possibly even more. Such an arrangement would adequately prevent any fouling of the food-gathering apparatus and explains the consistently close association of the mouth and anus in the superfamily Sphaeronitida. On this assumption, the size of the anus may reflect the volume of material collected by the food-gathering organs and passed through the gut. Text-fig. 14 shows that during growth and evolution changes in the size of the anus occurred. The rate of ontogenetic size increase is lowest in the early species, *S. (S.) minor*, and highest for the youngest species for which adequate data exist, *S. (P.) variabilis*. Since there appears to be relatively little change in respiration rate between these species, the apparent increase in food-processing capacity may reflect more rapid growth in later species.

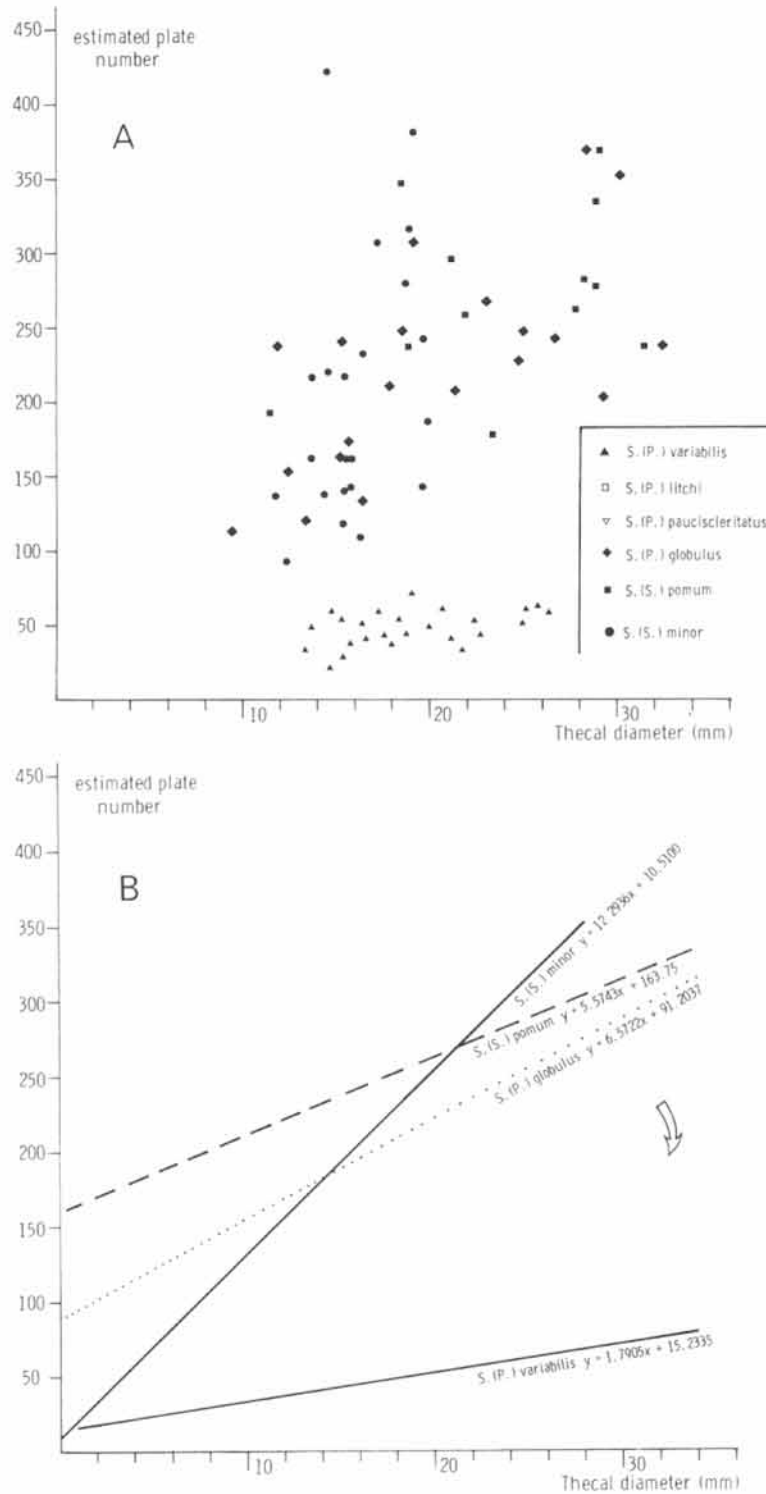

TEXT-FIG. 12. Graphs showing the relationship between estimated plate number and mean thecal diameter. A, scatter diagram; B, best fit lines (arrow indicates evolutionary trend).

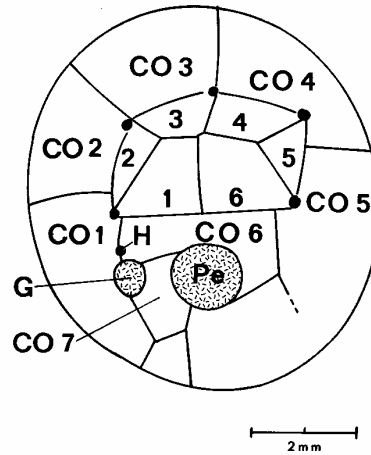

TEXT-FIG. 13. Diagrammatic oral area of *Sphaeronites* (based on *S. (Peritaphros) variabilis* sp. nov. RM Ec25419). 1-6, oral cover plates (palatals); CO1-CO7, circumoral plates; G, gonopore; H, hydropore; Pe, periproct.

### Respiration

Physiologists insist that respiration is an internal chemical process and that the process in our lungs, for example, is merely gas exchange. Only the latter can be considered here. The diplopores were the most important sites of gas exchange in *Sphaeronites*. Although the surface tissue and ambulacral appendages were bathed directly in sea water, all the internal organs received oxygen via the diplopores. In each diplopore two perpendicular canals pass right through the test and open externally in a pit or trough called the peripore, which was covered with soft tissue in life. Oxygen diffused in, and carbon dioxide out, through the soft tissue cover. In *Sphaeronites s.s.* the peripore is sunken, usually oval, and surrounded by a raised rim which bears tubercles or blunt spines (text-fig. 5A; Pl. 73, fig. 6). In *Peritaphros*, the two perpendicular canals open externally on either side of a large central tubercle and the peripore is reduced to a moat-like channel around the central tubercle (Pl. 73, fig. 7). The rim around the peripores is usually polygonal in outline and never bears tubercles or blunt spines. The new subgenus, *Ataphros*, is erected here for a species of *Sphaeronites* with diplopores in which only the central tubercle and perpendicular canals remain (Pl. 73, fig. 8). All trace of the peripore is lost, hence the subgeneric name, *Ataphros* (Greek, without a canal). In all three types of diplopores the same general circulation existed, with coelomic fluids ascending one perpendicular canal, gaining oxygen, and losing carbon dioxide via the soft tissue cover and the oxygenated fluids descending back into the thecal cavity via the other perpendicular canal. Separation of oxygenated and deoxygenated water was thus maintained within the diplopores.

In diplopores of *Sphaeronites s.s.* we have assumed a flat soft tissue cover over the entire area of the peripore (text-fig. 15A). In life the actual cover may have extended away from the thecal surface to some (unknown) extent which would have increased the potential exchange surface, but may not have achieved more efficient exchange (see below). In the diplopores of *Peritaphros* the soft tissue cover can be restored in two different arrangements (text-figs. 15C, D). It may either have continued over the central tubercle as in *Sphaeronites s.s.* or it may have been confined to the moat-like channel around the central tubercle. Computer-generated estimates of the exchange capacity of either arrangement show that in the former, exchange rates of *Peritaphros* were about the same or slightly greater than those for *Sphaeronites s.s.*, while the latter arrangement gave values about one-tenth those of *Sphaeronites*. We have concluded therefore that the former arrangement was the more likely. Other features of morphology suggest that the two subgenera had similar growth rates and food-gathering capacities and it seems likely that they also had similar respiratory capacities. In *Ataphros* we also assume that the soft tissue cover continued over the central tubercle (text-fig. 15B), but estimates of exchange capacity are impossible as we cannot measure the other parameters of the

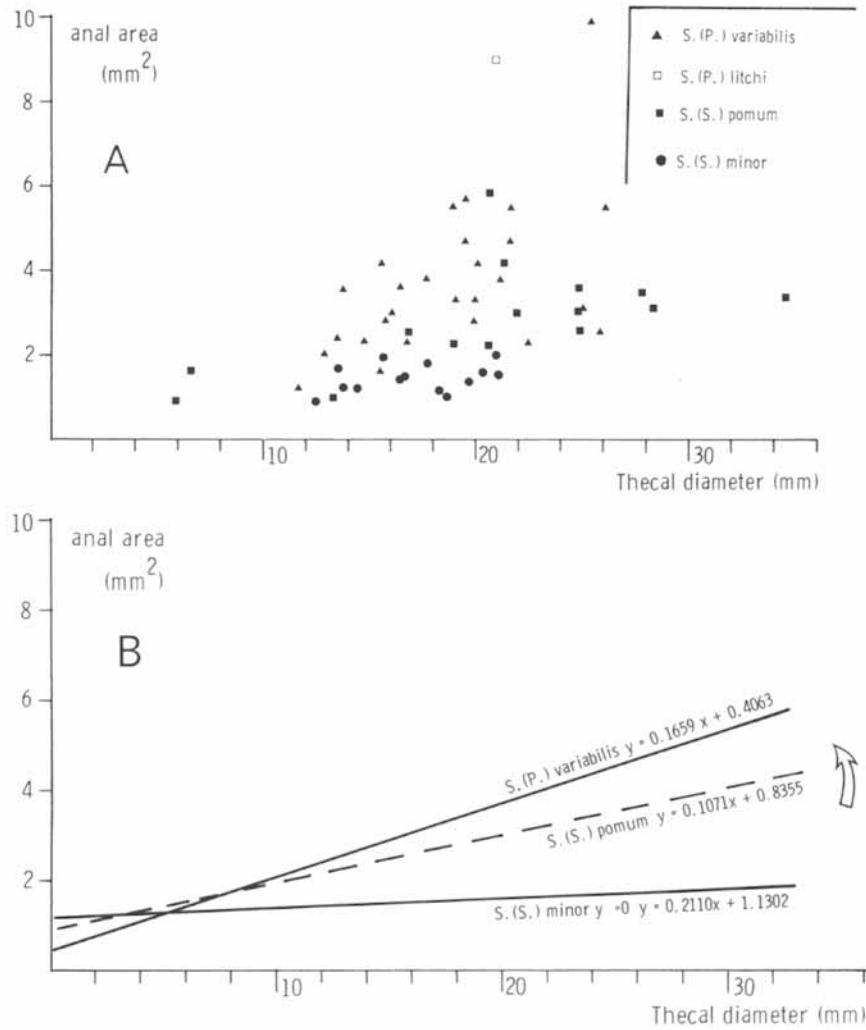

TEXT-FIG. 14. Graphs showing the relationship between area of periproct and mean thecal diameter. A, scatter diagram; B, best fit lines (arrow indicates evolutionary trend).

diplopores. We believe that the change from *Sphaeronites s.s.* to *Peritaphros* involved an increase in the efficiency of the circulating currents. In the diplopores of *Sphaeronites* coelomic fluids may take a short cut between the perpendicular canals without coming into intimate contact with the exchange surface (text-fig. 15A). In the diplopores of *Peritaphros*, however, the large central tubercle ensures that the fluids come close to the soft tissue cover. In our reconstructions we have assumed a gap between the central tubercle and the soft tissue cover equal to the perpendicular canal diameter. The change ensured a greater ratio of exchange surface area to peripore volume in the diplopores of

*Peritaphros*, and the elimination of the peripore walls in *Ataphros* may have taken this a stage further. Stratigraphically, *Sphaeronites s.s.* is confined to the upper Arenig or lowest Llanvirn of Sweden; *Peritaphros* ranges from the Llandeilo to the middle Ashgill, while *Ataphros* is only known from the lower Ashgill of South Wales. The stratigraphic occurrence of the three types of diplopores suggests evolution towards more efficient types of diplopores on the interpretations made in text-fig. 15.

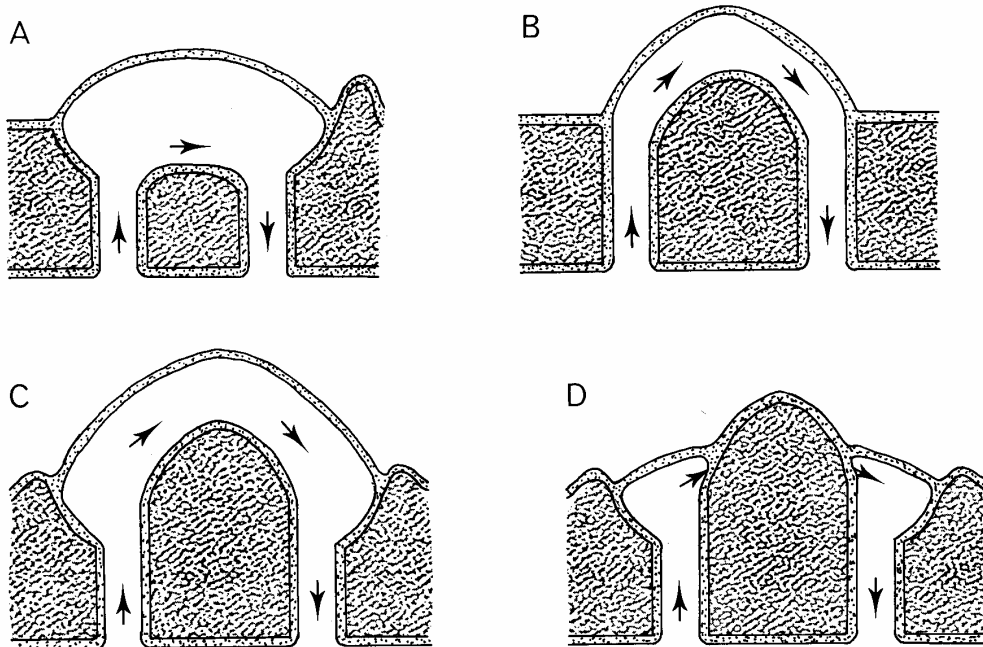

TEXT-FIG. 15. Inferred soft tissue cover in diplopores of *Sphaeronites s.s.* (A), *Ataphros* subgen. nov. (B), and two alternatives for *Peritaphros* Paul (C and D). Computer programs infer that reconstruction (C) is more likely. Soft tissue stippled. Arrows indicate current direction for internal coelomic fluids.

In addition to this change in overall morphology, the density of diplopores on the thecal surfaces decreases throughout the Ordovician (text-fig. 16; see also Paul 1973, fig. 14b), from a high of over six diplopores per  $\text{mm}^2$  in *S. (S.) minor* sp. nov. to a low of about one and half per  $\text{mm}^2$  in *S. (P.)* sp. A. The original measurements of diplopore density (Paul 1973) were made on a limited sample using a squared graticule eyepiece in a binocular microscope. Some additional measurements used in this paper were made by Bockelie from camera lucida drawings. Despite the different techniques and sample sizes, both the actual density measurements and the overall trends found were very similar so we have combined our data in this paper.

Diplopore density is effectively independent of size (text-fig. 18) over a range of thecal diameters from 9 to 38 mm in *S. (P.) globulus* and from 11 to 26 mm in *S. (P.) variabilis*. The decrease in the density of diplopores through the Ordovician is at least partly due to an increase in their size as well as a change in the closeness of packing. To investigate and interpret this trend more thoroughly we made the measurements shown in text-figs. 7D and 7E. We find (Table 2) that the diameter and separation of the perpendicular canals do not change greatly, but that the width of the peripores shows a marked increase throughout the Ordovician. Computer programs indicate that it is more efficient to increase

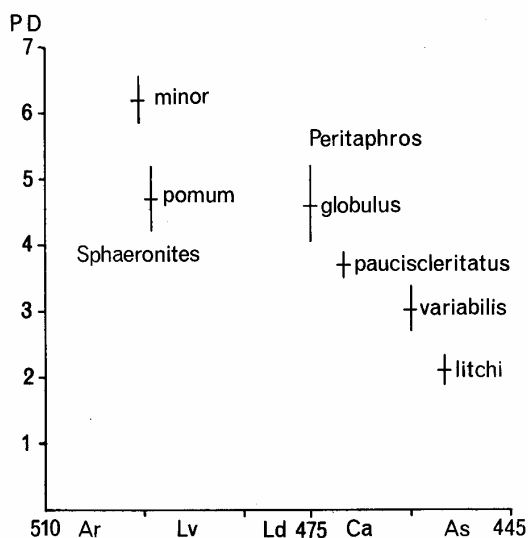

TEXT-FIG. 16. Evolutionary trend towards declining diplopore density in *Sphaeronites* throughout the Ordovician. Horizontal lines represent mean pore-density, vertical bar  $\pm$  one standard deviation. PD, pore density. Horizontal scale in millions of years and series. Ar, Arenig; Lv, Llanvirn; Ld, Llandeilo; Ca, Caradoc; As, Ashgill. In all cases the age of each species is taken as that of its *first* occurrence.

the area of the exchange surface by widening it perpendicular to the current direction than by lengthening it parallel to the current direction (Paul 1978, p. 282). Thus the trend appears to reflect a means of increasing the efficiency of the diplopores by enlarging their width in preference to their length. In *S. (P.) litchi* a further modification occurred because the central tubercle rises well above the general test surface. Thus, although the separation of the perpendicular canals is almost the same as that of the much older *S. (S.) pomum*, the actual path followed by the coelomic fluids was considerably longer, probably further than in *S. (P.) variabilis* which has the widest separation of perpendicular canals of any species.

One of us has developed computer programs to simulate the gas exchange in the diplopores, the main details of which have been published elsewhere (Paul 1978). These programs were used to investigate quantitatively the functional significance of the changes in the diplopores of *Sphaeronites*. Before presenting the results, a brief review of the assumptions of the computer programs and reconstructions of the mode of functioning of *Sphaeronites* diplopores is necessary.

TABLE 2. Mean measurements of diplopores in *Sphaeronites*

Species	Mean Measurements (mm)					
	Perpendicular canal separation	*N	Perpendicular canal diameter	*N	Peripore width	*N
<i>S. minor</i>	0.2437	24	0.0674	24	0.2404	24
<i>S. pomum</i>	0.2914	30	0.0709	30	0.2802	29
<i>S. globulus</i>	0.2383	20	0.0936	20	0.3983	17
<i>S. pauciscleritatus</i>	0.2667	9	0.0506	9	0.3866	9
<i>S. variabilis</i>	0.3447	28	0.0693	20	0.4374	28
<i>S. litchi</i>	0.2889	7	0.0998	7	0.6169	7

\* N is the number of specimens on which measurements were made. Up to twenty measurements were made of perpendicular canal separation, up to forty for perpendicular canal diameter, and up to sixty for peripore width, on each specimen.

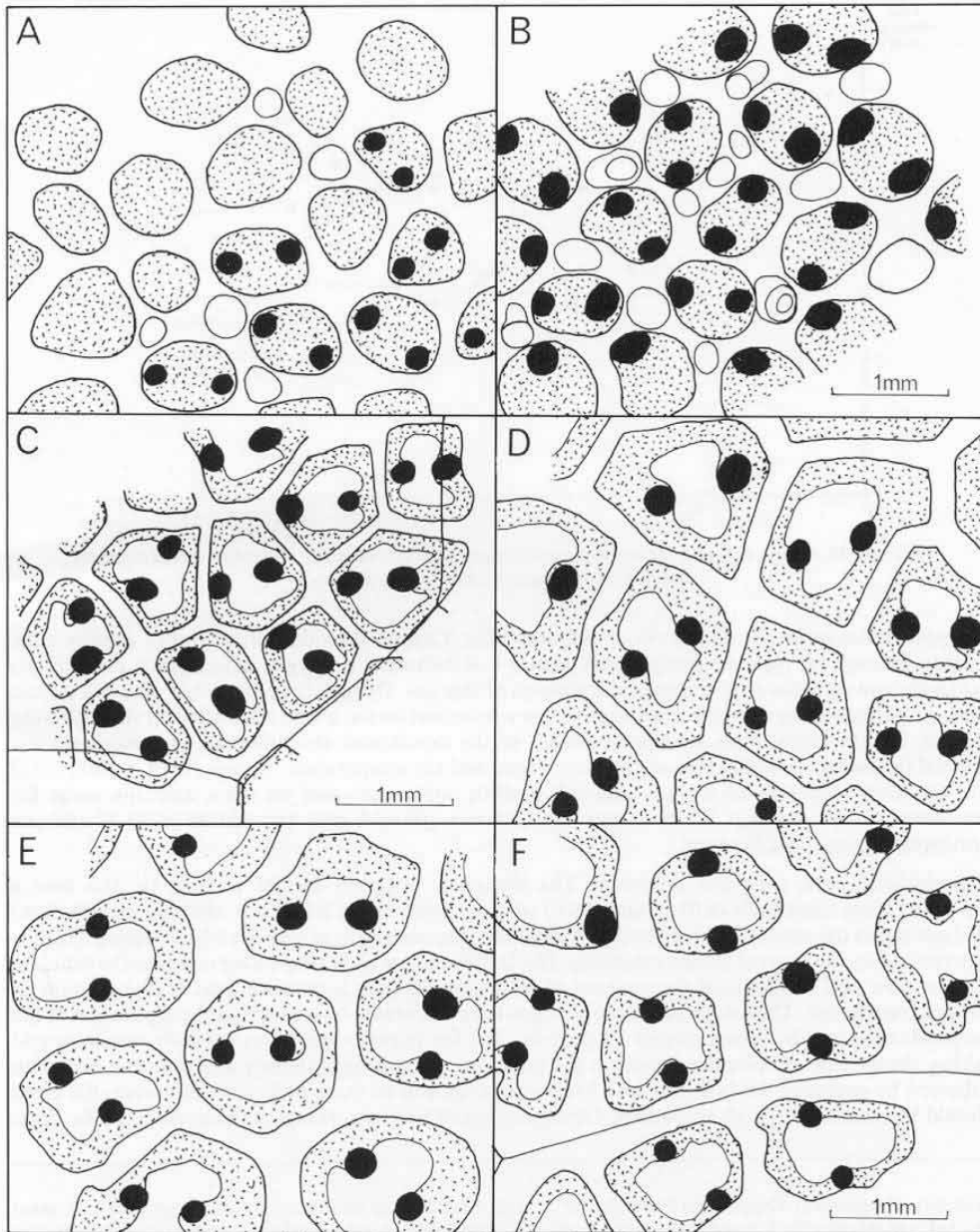

TEXT-FIG. 17. Camera lucida drawings of the diplopores of species of *Sphaeronites* s.s. and *Peritaphros* Paul. A, *S. (S.) minor* sp. nov.; B, *S. (S.) pomum*; C, *S. (P.) globulus*; D, *S. (P.) variabilis* sp. nov.; E, *S. (P.) pyriformis*; F, *S. (P.) litchi*. Perpendicular canals black; peripores stippled; peripore walls and tubercles white.

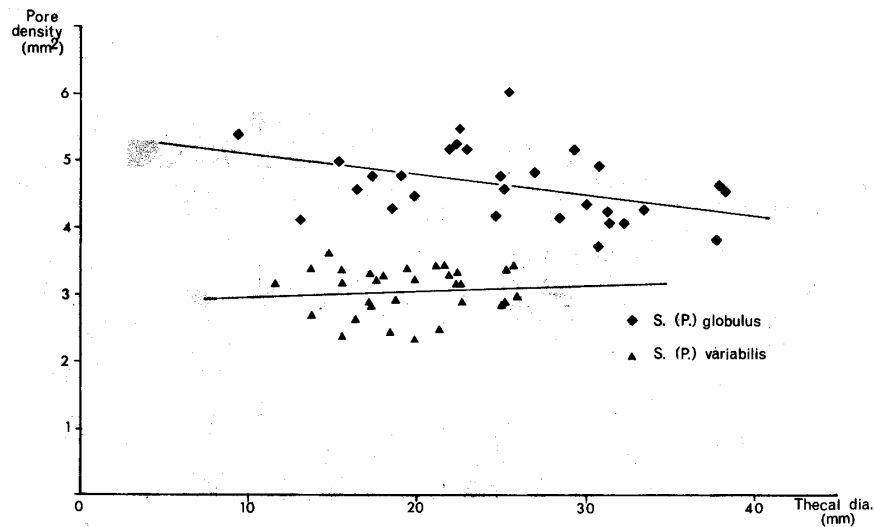

TEXT-FIG. 18. Graph showing the relationship between diplopore density and mean thecal diameter. Solid lines represent Bartlett's best fit lines.

*Oxygen exchange in the diplopores of Sphaerionites.* Carbon dioxide diffuses more rapidly than oxygen through all types of living tissue. Hence it is diffusion of oxygen which limits rates of gas exchange and we have only considered transport of this gas. Oxygen (and any other gas) will diffuse across a permeable membrane from high to low concentrations at a rate controlled by the following factors: the thickness, area, and permeability of the membrane, the difference in concentrations (partial pressures) on either side of the membrane, and the temperature. Krogh (1919, p. 408) listed the diffusion constants of oxygen through various substances and we have used his value for connective tissue—namely, 0.115 ccs per  $\mu\text{m}$  thickness, per  $\text{cm}^2$  area, per minute @ 20 °C and one atmosphere pressure difference.

*Assumptions of the computer programs.* The computer program divides a canal (in this case a diplopore) into narrow slices (0.01 mm thick) perpendicular to the length (i.e. the current direction) and calculates the amount of oxygen that will diffuse into each strip in turn for a brief period which is determined by the current velocity (text-fig. 19). It then moves each strip along one place to simulate current flow and recalculates the amount of diffusion, keeping a running total of the amount of oxygen transferred. The length of a diplopore has been calculated by measuring the separation of the perpendicular canals (measurement 13, text-fig. 7D) for twenty diplopores on each specimen and taking the average. Diplopore length in the computer programs is slightly less than the real path followed by coelomic fluids in life, and hence exchange will be marginally low. However, the error should be consistent for all specimens. Diplopore width has been taken as the average of the three

TEXT-FIG. 19 (opposite). Diagram to illustrate the basis of the computer programs. *a*, starting time (0) with canal divided into empty cells; *b*, canal with some oxygen in it after diffusion (small arrows) for time  $t$ ; *c*, cells shifted to simulate current flow (large arrow) and contents of cell 1 stored; *d*, after first cycle (time  $nt$ ) with contents of  $n$  cells stored; *e*, situation after a second cycle (time  $2nt$ ) with store full of cells with maximum oxygen concentration. The store is set to zero after each cycle. Rate of exchange is the total oxygen in the store divided by the time.



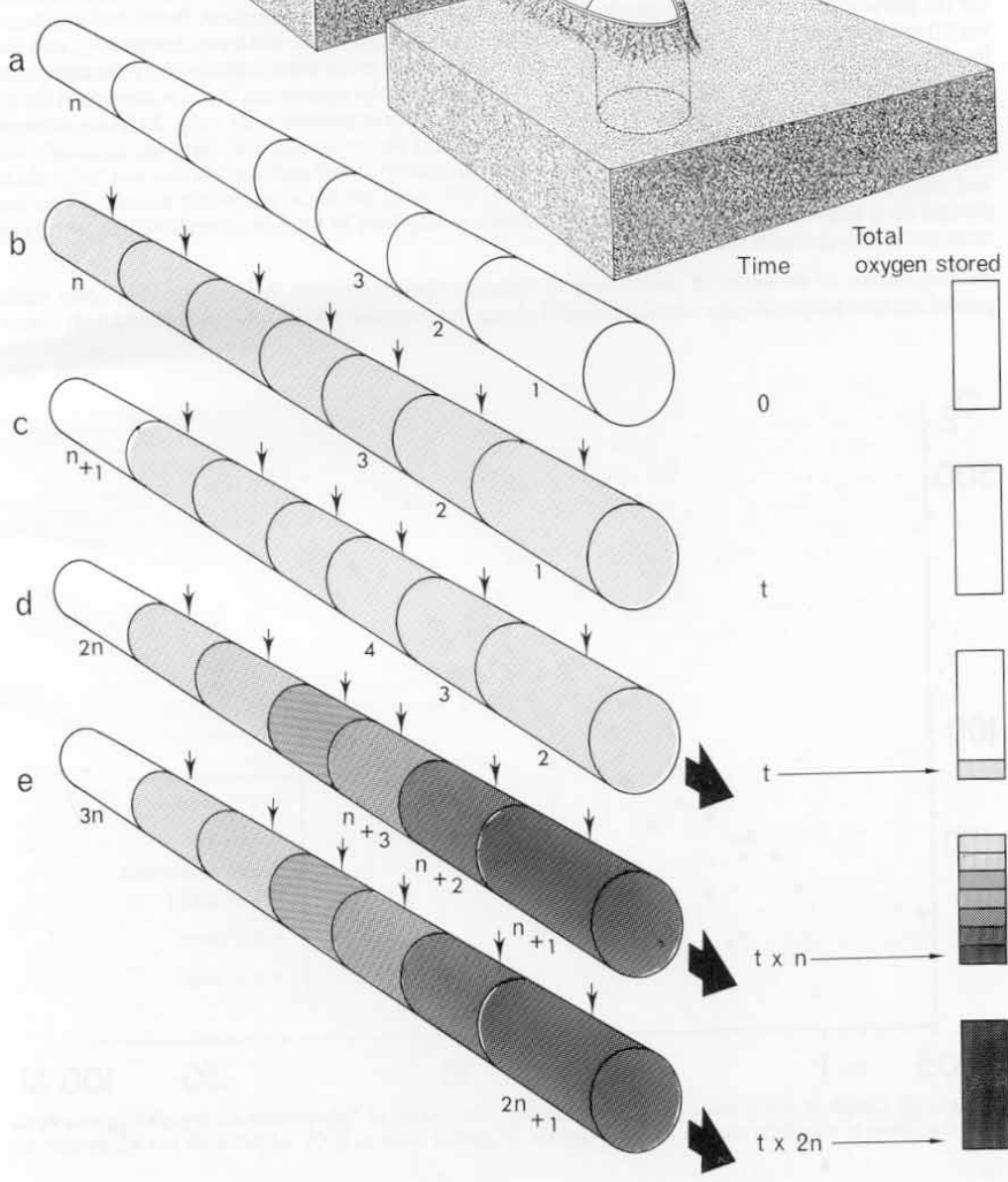
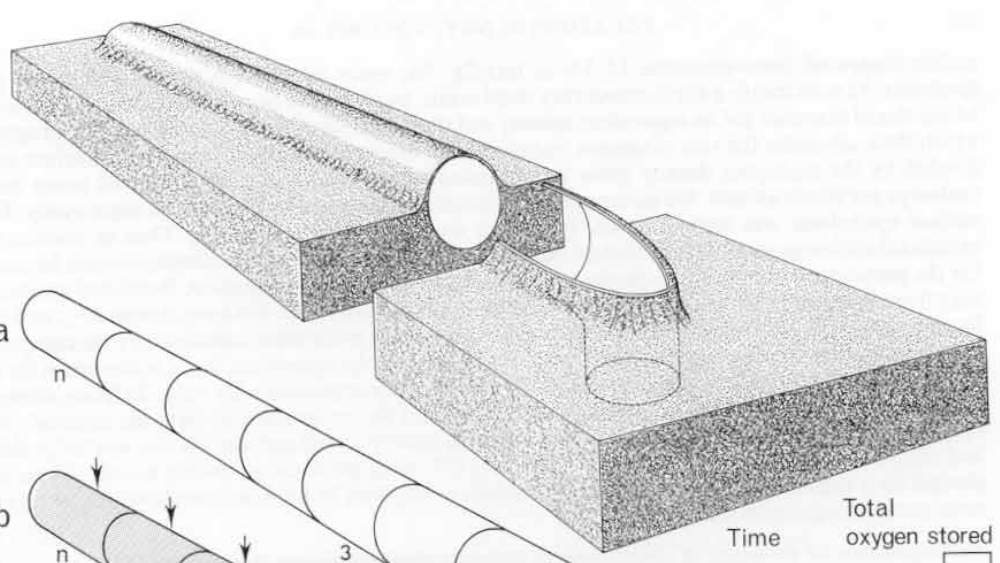

widths measured (measurements 14–16) in text-fig. 7D, again taken from twenty diplopores per specimen. As with length a slight inaccuracy must occur, but it should be consistent for all specimens. Mean thecal diameter (of an equivalent sphere) and diplopore density are also fed into the program which then calculates the rate of oxygen transfer for an average diplopore. Total thecal-surface area divided by the diplopore density gives an estimated total number of diplopores and hence total exchange per whole animal. We assume that all this oxygen was used by the internal organs only. The surface epithelium was bathed in sea water and oxygenated directly in life. Thus in comparing calculated exchange rates with published rates for living echinoderms, some allowance must be made for the proportion of internal respiration compared with epithelial respiration. Published estimates vary from 10 to 60% (Webster and Giese 1975; Farmanfarmaian 1966). We have chosen 50%, and the figures quoted for total exchange rate in this paper are exactly twice those calculated by the computer programs for transfer through the diplopores. Again this may be inaccurate, but it is consistent for all specimens of all species and hence evolutionary and growth comparisons are valid. In living animals respiratory rate varies with size, among other things. So the programs calculate the mass of each specimen in life assuming that soft tissue had a specific gravity of one and that the test was 50% calcite and 50% soft tissue. Exchange rates are quoted as  $qO_2$  in  $\mu\text{l}$  per hour per whole animal. These are plotted on a log:log graph (text-fig. 20). The slopes of any best fit lines indicate how  $qO_2$  in ml per hour per g changes with growth.

*Reconstruction of the mode of functioning of Sphaeronites diplopores.* We assume that body fluids passed up one perpendicular canal, travelled along the peripore which was roofed with soft tissue,

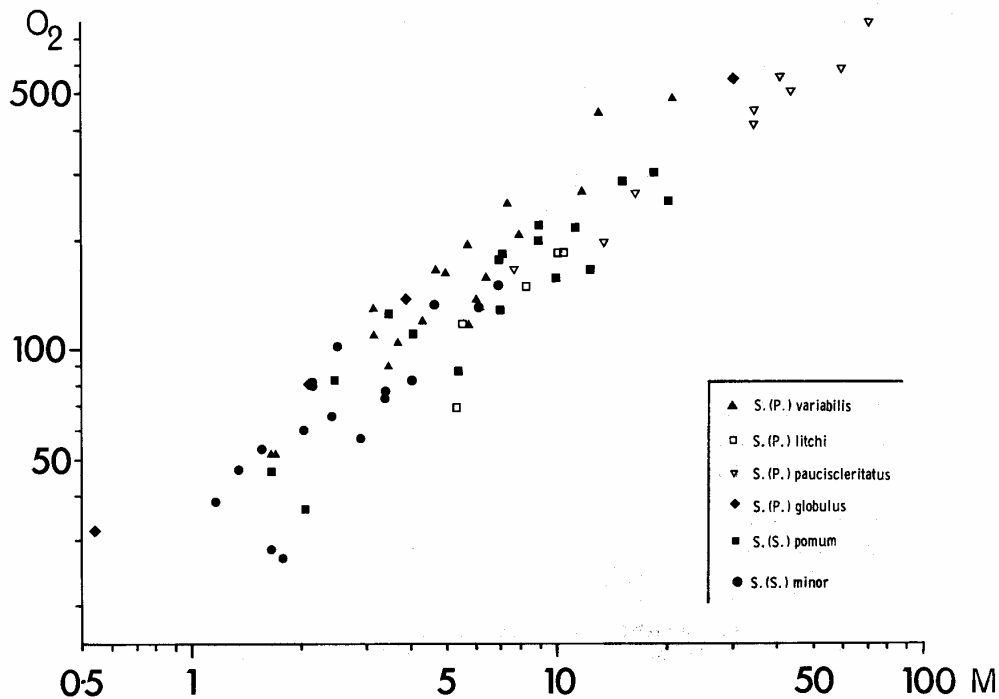

TEXT-FIG. 20. Graph of whole echinoderm exchange rates for species of *Sphaeronites* s.s. and *Peritaphros* Paul. Note that there is very little change between species. M, thecal mass in g;  $O_2$ ,  $\mu\text{l}$  per hour per whole animal.

and returned down the other perpendicular canal. Specialized respiratory tube-feet of modern echinoids have ciliated external epithelium, but the internal epithelium is only ciliated where it passes through the test (Nichols 1959b, p. 539). Hence we have accepted Gray's (1928, table 5, p. 76) velocity of 0.06 cm per second for ciliary currents at 20 °C as the velocity of the coelomic fluids within the perpendicular canals. Elsewhere in the peripore the current velocity will have been inversely proportional to the cross-sectional area at any point. We have assumed a flat cover to the peripore in *Sphaeronites* s.s. and calculated current velocity accordingly. In *Peritaphros* we have assumed that the cover was continuous and raised over the central tubercle by the width of the tangential canals (measurement 19, text-fig. 7E). Again current velocity within the peripore has been calculated accordingly.

We have assumed that the surrounding sea water was saturated with oxygen at present day levels (0.0052 ml per litre at 20 °C), which incidentally also assumes present day salinity levels. We are aware that Ordovician oceans may not have contained the same amounts of salts or gases. However, the assumption is the only one reasonable if the results are to be compared with known exchange rates in living echinoderms, since most respirometry experiments involve saturated sea water. Oxygen diffuses approximately three times as fast through sea water as through connective tissue (Krogh 1919, p. 408), and since the diplopores were, so to speak, bathed in an infinite reservoir of oxygenated sea water, we have assumed that all oxygen removed from sea water adjacent to a diplopore was replaced immediately. Nichols (1959a, p. 84; 1959b, p. 551) gives thicknesses of 1.3 and 10  $\mu\text{m}$  respectively for the walls of respiratory tube-feet in *Echinocyamus pusillus* (O. F. Müller) and *Echinocardium cordatum* (Pennant). To judge from his figures, Fenner (1973) gives values ranging from about 10 to 105  $\mu\text{m}$  for other modern echinoids, while Smith (1978) gives values of 2–10  $\mu\text{m}$  for specialized respiratory tube-feet of regular echinoids. Hence we have run the *Sphaeronites* programs with assumed thicknesses from 5 to 100  $\mu\text{m}$  for the walls of *Sphaeronites* diplopores. There are reasons, outlined below, for believing that the actual thickness was between 10 and 50  $\mu\text{m}$  and a standard thickness of 20  $\mu\text{m}$  has been used in evolutionary comparisons. Results (text-fig. 20) are presented as a log:log plot of exchange rate against thecal mass.

### Results

Text-fig. 20 shows no clear evolutionary trend in respiratory capacity, although there is an obvious increase in total gas exchange with growth. Exchange rates for living animals are frequently quoted in  $\mu\text{l}$  per g, and this value decreases with increased size during ontogeny in *Sphaeronites* as in all other invertebrates. From text-fig. 20 it would seem that the evolutionary trend in diplopore density, together with the changes in diplopore morphology, had very little effect on the total respiratory exchange. However, if the degree of saturation with oxygen achieved within the diplopores is compared, a distinct trend appears. Text-fig. 21 shows per cent saturation plotted against thickness of cover for three species, *S. (S.) minor*, *S. (P.) globulus*, and *S. (P.) litchi*. The other species fit on the graphs in accordance with their stratigraphical position, but make the diagram less clear so they have not been plotted. Thus it would seem that the evolutionary trend in diplopore density achieved approximately the same exchange rate, but with progressively fewer, more efficient diplopores. This evolutionary increase in saturation can be used to estimate the thickness of the soft tissue cover to the diplopores if one assumes that the trend arose through natural selection. Selection could only have been effective at thicknesses which produced a considerable change in saturation. For example, with an infinitely thin membrane, diplopores of all species of *Sphaeronites* would have achieved 100% saturation. Equally, with an infinitely thick membrane, 0% saturation would occur in all species. Text-fig. 21 shows that the maximum change in saturation occurs at about 20  $\mu\text{m}$  thickness, from about 39% in *S. (S.) minor* to about 79% in *S. (P.) litchi*. This thickness is somewhat greater than occurs in respiratory tube-feet of modern sea urchins (Andrew Smith, pers. comm.), but it is not by any means impossible. Of course, the possibility that different species of *Sphaeronites* may have had diplopore walls of different thickness cannot be excluded, but we have no means of determining this at present. A standard thickness of 20  $\mu\text{m}$  has

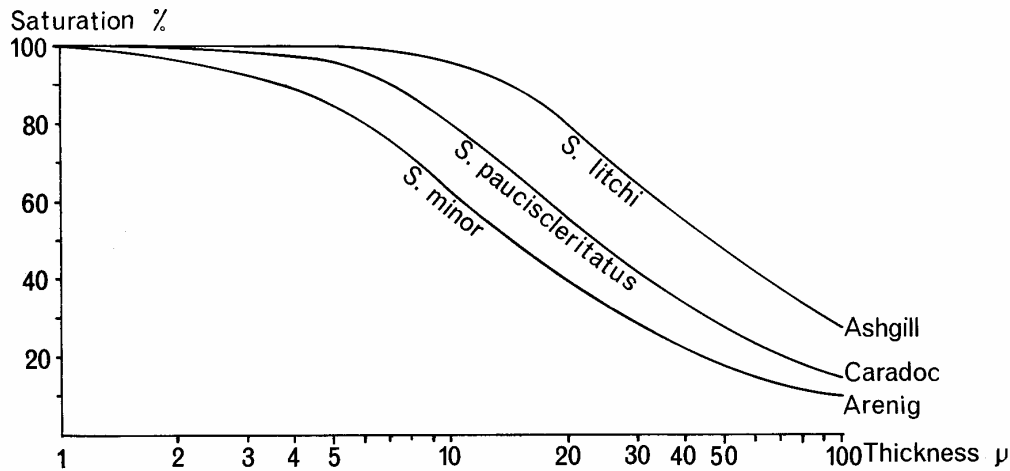

TEXT-FIG. 21. Graph showing the relationship between saturation of coelomic fluids and thickness of peripore cover in one early, one middle, and one late Ordovician species. Maximum difference in saturation, on which selection could have operated, is at 20  $\mu$ m. This thickness was adopted as standard in all other computer programs.

been assumed in comparisons between species because this thickness produces the maximum change in saturation.

If we accept the 20  $\mu$ m thickness for the diplopore walls, it becomes possible to convert the maximum exchange rate into calorific and food values. One litre of oxygen used in metabolism yields approximately 4.8 kcal. Various foodstuffs also yield known ranges of calories on oxidation (Prosser *et al.* 1950, table 40, p. 237) as follows:

1 g carbohydrate yields	4.2 kcal
1 g protein yields	4.2 kcal
1 g fat yields	9.5 kcal

Available data on the food of modern crinoids are very meagre (Rutman and Fishelson 1969), but suggest that it was composed mainly of protein and carbohydrate, rather than fat. Taking an average figure of 4.2 kcal per g, this gives an oxygen equivalent of 1.143 g of food per litre of oxygen. *Sphaeronites* species had potential exchange rates which varied from twenty-eight to 623  $\mu$ l oxygen per hour, which convert to a maximum food consumption of 32.004 to 712.089  $\mu$ g food per hour. Present-day sea water contains wide ranges of suspended organic matter, but a range of 1–5 mg (1000–5000  $\mu$ g) per litre is reasonable for shallow seas such as *Sphaeronites* inhabited. Taking the lower figure, this gives filtration rates of 32–712 ml per hour. These figures may be used to estimate the length of the food-gathering organs in *Sphaeronites*, which are never preserved and remain largely unknown in the Diploporita generally. Brachioles in rhombiferans are generally 0.5 mm in diameter, and if we assume tube-feet 250  $\mu$ m long stretched widely on either side then each brachiole could filter a path 1 mm wide. With a ciliary current of 0.06 cm per second the required volumes of water represent filter areas from 14.8 to 330 mm<sup>2</sup> in thecae ranging from 5 to 50 mm diameter. If the appendages were all of equal length and if half the food ingested was assimilated, this gives a minimum of five brachioles (i.e. one per radius) about 6 mm long in a 5 mm diameter theca and a maximum of fifteen brachioles (i.e. three per radius) about 44 mm long in a 50 mm diameter theca. Thus throughout the growth of all *Sphaeronites* species, unbranched appendages of a length approximately equal to the thecal diameter could have gathered sufficient food to utilize all the oxygen absorbed by the animals.

## REPRODUCTION

Although hermaphroditism is known among living echinoderms, most species have separate sexes. We assume this was the case in *Sphaeronites*, but there is no evidence of sexual dimorphism to confirm it. Each specimen has a single gonopore and hence had a single internal gonad in life. The diameter of the gonopore increases slowly with increasing thecal size (text-fig. 22) and there is no clear evolutionary trend affecting the position or size of this orifice. Presumably eggs and sperm were shed directly into the sea water. Modern starfish and echinoids have a trigger, the shedding substance, which induces simultaneous shedding among mature adults of the same species. Such a mechanism is most effective if all individuals shed for approximately the same time-span. The increase in the diameter of the gonopore during growth may be interpreted as a mechanism to speed up shedding from a (presumably) larger internal gonad. The scatter of gonopore diameters in *S. (P.) globulus* (text-fig. 22) suggests a relatively rapid increase at about 22–24 mm thecal diameter. This might indicate the onset of sexual maturity, but equally it may simply arise by chance. More observations are required before this idea can be confirmed.

The previous consideration of the vital functions of *Sphaeronites* throughout growth and evolution suggests that later species were better protected than earlier ones, and that their diplopores achieved the same exchange capacities in a more efficient manner. Although our calculations make a large number of assumptions, we are convinced that they contribute to an understanding of the mode of life and evolution of *Sphaeronites*. In particular, quantitative analysis of feeding and respiration using computer programs has allowed us to reconstruct with some confidence anatomical features in *Sphaeronites* which have never been found preserved and hence cannot be observed directly. We can suggest that the cover to the diplopores in *Peritaphros* was continuous over the central tubercle, rather than confined to the moat-like channels of the peripore because the latter arrangement gives only a tenth the exchange capacity. We can suggest that the cover of all diplopores in *Sphaeronites* was 20  $\mu\text{m}$  thick, because then selection would have been most effective in increasing saturation of coelomic fluids. Finally, we can suggest that the food-gathering organs were probably unbranched and about as long as the thecal diameter because they could then gather adequate food to utilize the maximum amount of oxygen the animals could absorb. In our view such quantitative studies are a powerful tool in functional interpretations of extinct organisms.

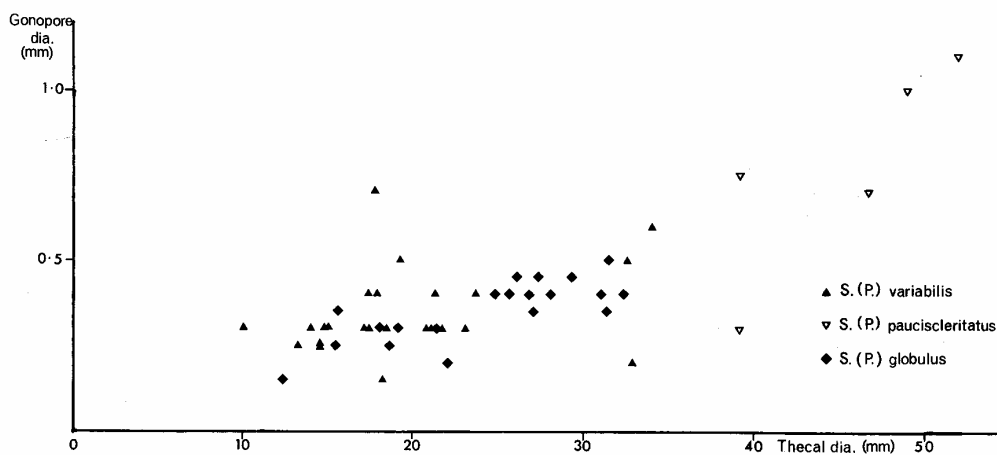

TEXT-FIG. 22. Graph showing the relationship between gonopore diameter and mean thecal diameter in *Sphaeronites s.s.* and *Peritaphros* Paul.

Class DIPLOPORITA Müller, 1854  
Superfamily SPHAERONITIDA Neumayr, 1889

For definition see Paul (1973, p. 18). The Superfamily Sphaeronitida contains two families, the Sphaeronitidae and the Holocystitidae. They are distinguished on their pore structures (diplopores *s.s.* in the Sphaeronitidae, humatipores in the Holocystitidae), on details of the plating arrangement in the oral area, and on ambulacral structures. For details see Paul 1971, pp. 68–72 (holocystitids), 1973, pp. 18, 19 (sphaeronitids).

## Family SPHAERONITIDAE Neumayr, 1889

*Diagnosis.* 'A family of Sphaeronitida with diplopores; peristome surrounded by six circum-oral plates with a small additional plate (CO7) between the peristome and periproct, but not in contact with the former; four or five ambulacra with one or more ambulacral facets each. (Paul 1973, pp. 18, 19).

Genus *Sphaeronites* Hisinger, 1828

- 1772 *Echinus* Gyllenhaal (*pars, non* Linnaeus, 1758), p. 242.  
 1818 *Echinospaerites* Wahlenberg (*pars*), p. 54.  
 1828 *Sphaeronites* Hisinger, p. 195.  
 1854 *Sphaeronites* Hisinger; Müller, p. 186.  
 1878 *Sphaeronis* [*sic*] Hisinger; Angelin, p. 30.  
 1879 *Sphaeronites* Hisinger; Zittel, p. 417.  
 1896 *Pomonites* Haeckel, p. 96, fig. 6.  
 1896 *Sphaeronites* Hisinger; Haeckel, p. 98, fig. 7.  
 1899 *Sphaeronites* Hisinger; Jaekel, p. 396.  
 1900 *Sphaeronis* [*sic*] Hisinger; Bather, p. 71.  
 1943 *Sphaeronites* Hisinger; Bassler and Moodey, pp. 6, 189.  
 1945 *Sphaeronites* Hisinger; Regnéll, p. 161.  
 1967 *Sphaeronites* Hisinger; Kesling, p. S243, fig. 142: 1a–e.  
 1973 *Sphaeronites* Hisinger; Paul, p. 19.

*Type species.* *Echinus pomum* Gyllenhaal, 1772, by original designation, Müller 1854, p. 242, pl. 8, figs. 1–3; from the Asaphus Limestone (Arenig), Kinnekulle, Västergötland, Sweden.

*Diagnosis.* A genus of Sphaeronitidae with globular to pyriform or fusiform theca composed of forty to two hundred or more plates which are irregularly arranged except in the oral area; peristome and periproct very close together on smooth oral prominence; five ambulacra with one to three facets each; all thecal plates uniformly covered with randomly orientated diplopores (except in attachment area); attachment direct.

*Remarks.* The most characteristic features of the genus are the very close approximation of the peristome and periproct, both of which are developed in a smooth, diplopore free area at the oral pole; and the evenly and densely developed diplopores. Other sphaeronitid genera (e.g. *Eucystis*, *Archeogocystis*, *Diplosphaeronis*) have the anus much further from the mouth, while the diplopores of *Haplosphaeronis* and *Palaeosphaeronites*, two genera with closely approximated peristomes and periprocts, are quite different from those of *Sphaeronites* as here understood. All genera except *Diplosphaeronis* have much more widely spaced diplopores which usually have oval peripores.

Close examination of the diplopores of *Sphaeronites* has shown that they fall into three distinct types. In the type species, *S. pomum* (Gyllenhaal), all the diplopores are deeply sunken into the thecal surface, have oval or rounded peripores, and have small blunt spines developed on the peripore rim (Pl. 73, fig. 6; text-fig. 5A). In contrast, the diplopores of *S. globulus* (Angelin) are not deeply sunken, have no spines or tubercles on the peripore rims, but have a single large central tubercle within the

peripore and between the two perpendicular canals; the peripore is thus reduced to a moat-like channel around the central tubercle (Pl. 72, fig. 11; text-fig. 5B). *S. insuliporus* sp. nov. has diplopores which completely lack a peripore; only the central tubercle and pair of perpendicular canals remain (Pl. 73, fig. 8; text-fig. 5C). The diplopores of all species of *Sphaeronites* that we have examined fall into one or other of these three types which are used to distinguish three subgenera: *Sphaeronites s.s.*, *Peritaphros* Paul, 1973, and *Ataphros* subgen. nov. Stratigraphically *Sphaeronites* (Arenig-Llanvirn) precedes *Peritaphros* (Llandeilo-Ashgill) which in turn precedes *Ataphros* (Ashgill). We recognize the following species of *Sphaeronites*:

- \**Sphaeronites (Sphaeronites) pomum* (Gyllenhaal, 1772); upper Arenig-lower Llanvirn, Sweden.
- S. (S.) minor* sp. nov.; upper Arenig, Sweden.
- \**Sphaeronites (Peritaphros) globulus* (Angelin, 1878); Llandeilo, Sweden.
- S. (P.) pauciscleritatus* sp. nov.; Caradoc, Norway.
- S. (P.) variabilis* sp. nov.; upper Caradoc-lower Ashgill, Sweden.
- S. (P.) litchi* (Forbes, 1848); lower-middle Ashgill, Wales.
- S. (P.) pyriformis* (Forbes, 1848) middle Ashgill, Wales.
- S. (P.)* sp. A.; lower Ashgill, Wales.
- \**Sphaeronites (Ataphros) insuliporus* sp. nov.; lower Ashgill, Wales.

\* Denotes type species.

In addition to these there are possible forms of *S. (P.) globulus* and perhaps another new species from the middle Ordovician of the Baltic States which are the subject of study by Professor Hecker. These undoubtedly also belong to *Sphaeronites* as understood here. Thus *Sphaeronites* is an exclusively Ordovician genus known only from the Baltic Province and, in the late Ordovician, from Wales. *Sphaeronites* was used as a catch-all generic name and a very large number of species has been included within it at one time or another. We cannot list all these here, but we draw attention to the following more recently described species, which, in our opinion, do not belong in *Sphaeronites*:

*Sphaeronis* [sic] *jenhochiaoensis* Sun, 1948 (p. 7) from China has the anus as much as 25 mm from the mouth and cannot be a *Sphaeronites* as we define the genus.

*Sphaeronites globulus* Termier and Termier, 1950 (pl. 228, fig. 1) from Algeria. The oral area is unknown and the specimen appears to be unidentifiable to judge from the illustration.

?*Sphaeronites* sp. Chauvel, 1966 (p. 65, pl. 2, fig. 12; pl. 4, fig. 10) from Morocco. Again the oral area is unknown, but this may well be an aristocystitid to judge from the diplopores.

#### Subgenus *Sphaeronites (Sphaeronites)*

*Type species. Echinus pomum* Gyllenhaal, 1772.

*Diagnosis.* A subgenus of *Sphaeronites*-bearing oval or rounded diplopores with blunt spines or tubercles on the rims between deeply sunken peripores; with flat or slightly convex peripore floors.

#### *Sphaeronites (Sphaeronites) pomum* (Gyllenhaal, 1772)

Plate 72, figs. 1, 2; Plate 73, fig. 6; text-figs. 5A, 17B, 24.

- 1945 *Sphaeronites pomum* (Gyllenhaal); Regnéll, p. 161, pl. 1, figs. 2, 3, 5; pl. 11, figs. 6-9, 12; pl. 12, figs. 2-4, 6; pl. 13, fig. 2; text-figs. 1: 1-3; 19: 1-3, 7-9; 20-21.
- 1948 *Sphaeronites pomum* (Gyllenhaal); Regnéll, pp. 13-14.
- 1960 *Sphaeronites pomum* (Gyllenhaal); Regnéll, p. 168.
- 1967 *Sphaeronites pomum* (Gyllenhaal); Kesling, p. S243, fig. 142: 1b, non fig. 142: 1a (= *S. globulus*).
- 1972 *Sphaeronites pomum* (Gyllenhaal); Paul, p. 25, pl. 5, fig. 2.
- 1973 *Sphaeronites (Sphaeronites) pomum* (Gyllenhaal); Paul, p. 23.
- 1978 *Sphaeronites pomum* (Gyllenhaal); Paul, p. 283.

For a complete synonymy see Regnéll (1945, p. 161). We have only listed references since that paper.

**Diagnosis.** A species of *Sphaeronites* s.s. with large theca (reaching 35–40 mm diameter); diplopores with well-developed peripore rims which bear short spines abundantly; four to five diplopores per mm<sup>2</sup>.

**Types.** Regnéll (1945, p. 162) selected a neotype (RM Ec2781) from Orthoceras Limestone, Kinnekulle, Västergötland, as Gyllenhaal's original material is apparently lost. However, Gyllenhaal's original description and figures are excellent and leave no doubt about which species was described in 1772.

**Material.** Hundreds of specimens from Kinnekulle Mountain and Öland, Sweden.

**Horizons and localities.** Regnéll (1945, pp. 167, 168) lists known localities. It is probable that some from Kinnekulle also refer to *S. (S.) minor* sp. nov. Our material comes from Österplana, Västergötland and from Södra Möckleby, Öland.

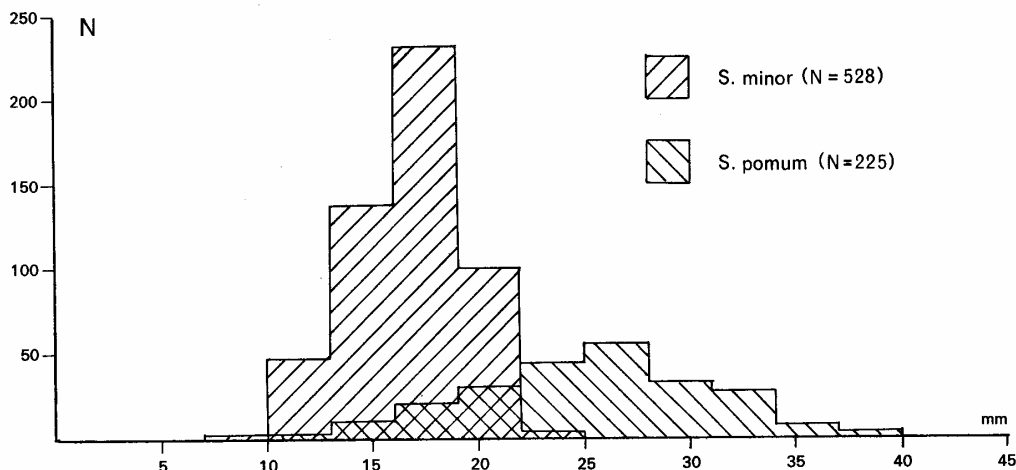

TEXT-FIG. 23. Frequency distribution of thecal diameter in *Sphaeronites (Sphaeronites) minor* sp. nov. and *S. (S.) pomum* from Österplana, Kinnekulle Mountain, Västergötland, Sweden. Note the wider range of sizes in *S. (S.) pomum*. Thecal diameter (mm), against number of individuals (N).

**Description.** Theca: spherical generally with a small oral platform and variable attachment area aborally. Often reaching 35–40 mm diameter (text-fig. 23) and with a very rough prickly surface when well preserved (pl. 72, figs. 1, 2).

**Plates:** numerous (as many as 450 plates estimated in a 35 mm diameter theca), small (mean area 7–9 mm<sup>2</sup>), and irregularly arranged. Plates are added during growth, but distinct generations of plates are not usually recognizable. Each plate bears numerous diplopores, although a narrow pore free zone may occur around the margin of the plates in some examples. All plates are slightly tumid so that the sutures are weakly impressed.

**Diplopores (text-figs. 5A, 17B):** densely packed over the theca. Peripores oval or rounded with flat or only slightly convex floors. Peripores reach 0.35–0.40 mm across with a pair of pores 0.05 mm in diameter set 0.2–0.35 mm apart. Peripore rims are well developed with prominent spines or tubercles developed at the junctions of three rims (text-fig. 5A). Spines reach 0.25 mm long on well-preserved examples from Öland (Pl. 72, figs. 1, 2), but are abraded on most examples either before deposition or, more commonly, as a result of weathering. The best-preserved examples display the prickly surface so well illustrated by Gyllenhaal (1772, pl. 8, fig. 3).

**Oral surface (text-fig. 24):** a small almost inconspicuous oral platform reaches 6 mm long (anterioposterior dimension) by 5 mm, but is usually a little smaller. The peristome is semicircular, small (2.0 mm by 2.5 mm) and covered by six palatal plates in rare examples. Ambulacral facets are rarely discernible. The periproct is small, circular, reaches 2 mm in diameter and is separated from the mouth by 0.4–0.5 mm. The gonopore is rarely detectable, but a small circular pore 0.15 mm in diameter is present in the usual position in SM A74827. A hydropore has not yet been confirmed.



TEXT-FIG. 24. Camera lucida drawings of the oral area of *Sphaeronites* (*Sphaeronites*) *pomum*. A, PMO A35283, upper *Sphaeronites* bed, Södra Möckleby, Öland, Sweden; B, SM A85676, *S. pomum* bed, Österplana, Kinnekulle, Sweden. 1-7, circum-oral plates; A, anus; G, gonopore; M, mouth.

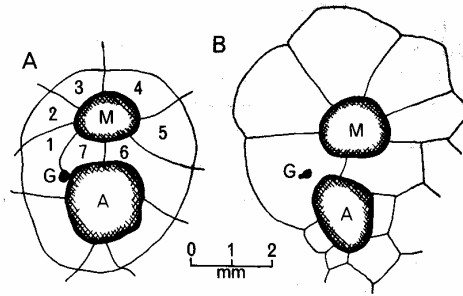

Internal structures: unknown. All the calcite-filled examples that we have ground down in the aboral area of the theca failed to yield any evidence of the hollow internal spine known in several species of *Peritaphros*.

Attachment: direct, by a variable attachment area. The only specimens still attached to their substrates are always attached to other specimens of *S. (S.) pomum*. Sections through these show that plates of the attachment area are only half as thick as the main thecal plates. Other attachment areas indicate that *S. (S.) pomum* lived on orthoconic cephalopods and other shells in life.

*Remarks.* Gyllenhaal's original illustrations (refigured in Regnéll 1945, fig. 1: 1-3) show quite clearly the very prickly surface of his species. We have confined our interpretation of this species to those forms which exhibit this very rough surface. In Västergötland another species with a smaller and smoother test occurs which is described below as *S. (S.) minor* sp. nov. Detailed comparisons of the two species are presented after the description of the new form.

*Sphaeronites* (*Sphaeronites*) *minor* sp. nov.

Plate 72, figs. 3, 7, 8; text-figs. 9, 17A, 25.

1972 *Sphaeronites* sp. nov. Paul, p. 25, pl. 5, fig. 1.

1973 *Sphaeronites* (*Sphaeronites*) sp. A, Paul, p. 23.

1978 *Sphaeronites minor* Paul, p. 283 (*nomen nudum*).

*Diagnosis.* A species of *Sphaeronites* s.s. with small theca (usually less than 25 mm at most); diplopores with well-developed peripore rims which bear occasional weak tubercles; about six diplopores per mm<sup>2</sup>.

*Types.* Holotype SM A35313 (Pl. 72, figs. 3, 8), numerous paratypes (PMO, RM, SM, and authors' collections).

*Material.* Hundreds of specimens, all from Kinnekulle.

*Horizons and localities.* Lower (Grey) Asaphus Limestone (upper Arenig or possibly lowermost Llanvirn) of Kinnekulle Mountain, Västergötland, Sweden, where specimens occur in densities up to 5,000 per m<sup>2</sup>. We have examined many hundreds of specimens from the *minor* bed and the overlying *pomum* bed at Kinnekulle. So far we have not found a single example of *pomum* in the *minor* bed or vice versa.

TEXT-FIG. 25. Camera lucida drawings of the oral area of *Sphaeronites* (*Sphaeronites*) *minor* sp. nov. A, SM A85644, B, SM A85618, C, SM A85629, all from *S. minor* bed, Österplana, Kinnekulle, Sweden. A, anus; D, diplopores; F, ambulacral facets; G, gonopore; M, mouth.

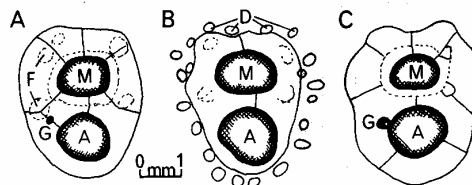

*Description.* Theca: globular to pyriform, depending on the size of the attachment area. Small, usually less than 20 mm diameter, rarely if ever exceeding 25 mm (text-fig. 23). Small raised oral platform and variable aboral attachment area.

Plates: numerous (300–400 estimated in larger thecae), irregularly arranged and small (usually only 4–5 mm<sup>2</sup> in area, largest 7 mm<sup>2</sup>). Each plate bears numerous diplopores, forty present on one plate which measures 2 × 3 mm.

Diplopores (text-fig. 17A): very densely and evenly developed over the theca, frequently crossing plate sutures. Peripores oval or polygonal (Pl. 72, fig. 7), the shape usually depending on adjacent diplopores because of the very dense packing. Peripore floor flat or gently convex, without a central tubercle. Peripores reach 0.25–0.30 mm across and contain a pair of pores 0.04 mm in diameter set about 0.2–0.3 mm apart. Peripore rims generally narrow and flat-topped. Where they meet, small blunt tubercles are sometimes developed, but they never form the spines characteristic of *S. (S.) pomum*. As a result the test surface appears to be much smoother than that of *S. (S.) pomum*.

Oral surface (text-fig. 25): the small oral platform reaches 4 × 3.5 mm and contains a semicircular to subquadrangular peristome 1.0 × 1.5 mm. Ambulacral facets are indistinct and close to the peristome border (Pl. 72, fig. 7). Palatals unknown. The periproct is circular, up to 1.5 mm in diameter and separated from the mouth by a calcite ridge 0.4–0.5 mm wide. In the holotype the peristome is smaller than the periproct, but the reverse is the case in SM A35315. Both orifices are surrounded by a smooth diplopore-free area which forms the raised oral platform (Pl. 72, fig. 7). Anal plates not preserved on any example we have examined. The gonopore is a small circular pore to the left of the peristome and periproct and midway between them. A hydropore has not been detected with certainty, but a slit-like impression (which might be a fortuitous crack) occurs between the peristome and periproct on the holotype. It is 0.3 × 0.03 mm.

Internal structures: as in *S. (S.) pomum* we have been unable to detect any internal spine.

Attachment: direct, by a variable attachment area. Again the only examples still attached occur epifaunally on other specimens of *S. (S.) minor*. Other substrates were the same as those of *S. (S.) pomum*.

*Remarks.* Although the presence of *S. (S.) minor* has been detected before, it has generally been included within *S. (S.) pomum s.l.*, Regnéll (1945, p. 166) summarized the situation and concluded: 'Anyhow, it is evident that *Sphaeronites pomum* in typical development was preceded by a smaller form which must be regarded as conspecific, however. Since there are no really distinguishing features, and variations in size are too vague to be used for diagnostic purposes, there is no reason to denote the smaller specimens by a separate name'.

In the absence of any diagnostic character other than size it is wise to refrain from erecting new species, as Prof. Regnéll argued. However, we believe that the higher diplopore density, smoother

#### EXPLANATION OF PLATE 72

Figs. 1–2. *Sphaeronites (Sphaeronites) pomum* (Gyllenhaal), Asaphus Limestone, Södra Möckleby, Öland, Sweden. Two small examples from the lower *Sphaeronites* bed which reveal the characteristic prickly surface of *S. (S.) pomum*. 1, PMO A35326; 2, PMO A35320.

Figs. 3, 7, 8. *Sphaeronites (Sphaeronites) minor* sp. nov., Orthoceras Limestone, Kinnekulle Mountain, Västergötland, Sweden. 3, lateral and 8, oral views of the holotype, SM A35313, near Råbäck. 7, oral view of paratype, PMO A37044, Österplana, which shows details of the diplopores and the oral platform.

Figs. 4, 14. *Sphaeronites (Peritaphros) litchi* (Forbes), Shoeshook Limestone, Shoeshook, South Wales. 4, oral view of PMO A35439, showing the oral platform and cover plates. 14, lateral view of a latex of the lectotype, IGS GSM 7431, showing the characteristic diplopores.

Figs. 5, 6, 10. *Sphaeronites (Peritaphros) variabilis* sp. nov., Boda Limestone, Dalarna, Sweden. 5, lateral and 10, oral views of the holotype, SGU, Gulleråsens Lissberg. 6, lateral view of paratype, RM Ec26516, Osmundsberget.

Figs. 9, 12, 13. *Sphaeronites (Peritaphros) pyriformis* (Forbes), Rhiwlas Limestone, near Bala, North Wales. 9, oblique view of lectotype, IGS GSM 102360, Rhiwlas. 12, lateral view of BM(NH) E16347; 13, lateral view of BM(NH) E16344; both from Llwyn-y-Ci and both showing the diplopores.

Fig. 11. *Sphaeronites (Peritaphros) globulus* (Angelin), Dalby Limestone, Bödahamn, Öland, Sweden. Oral view of RM Ec4193, showing ambulacral facets, gonopore, and characteristic diplopores.

All specimens whitened with ammonium chloride sublimate; all × 2.

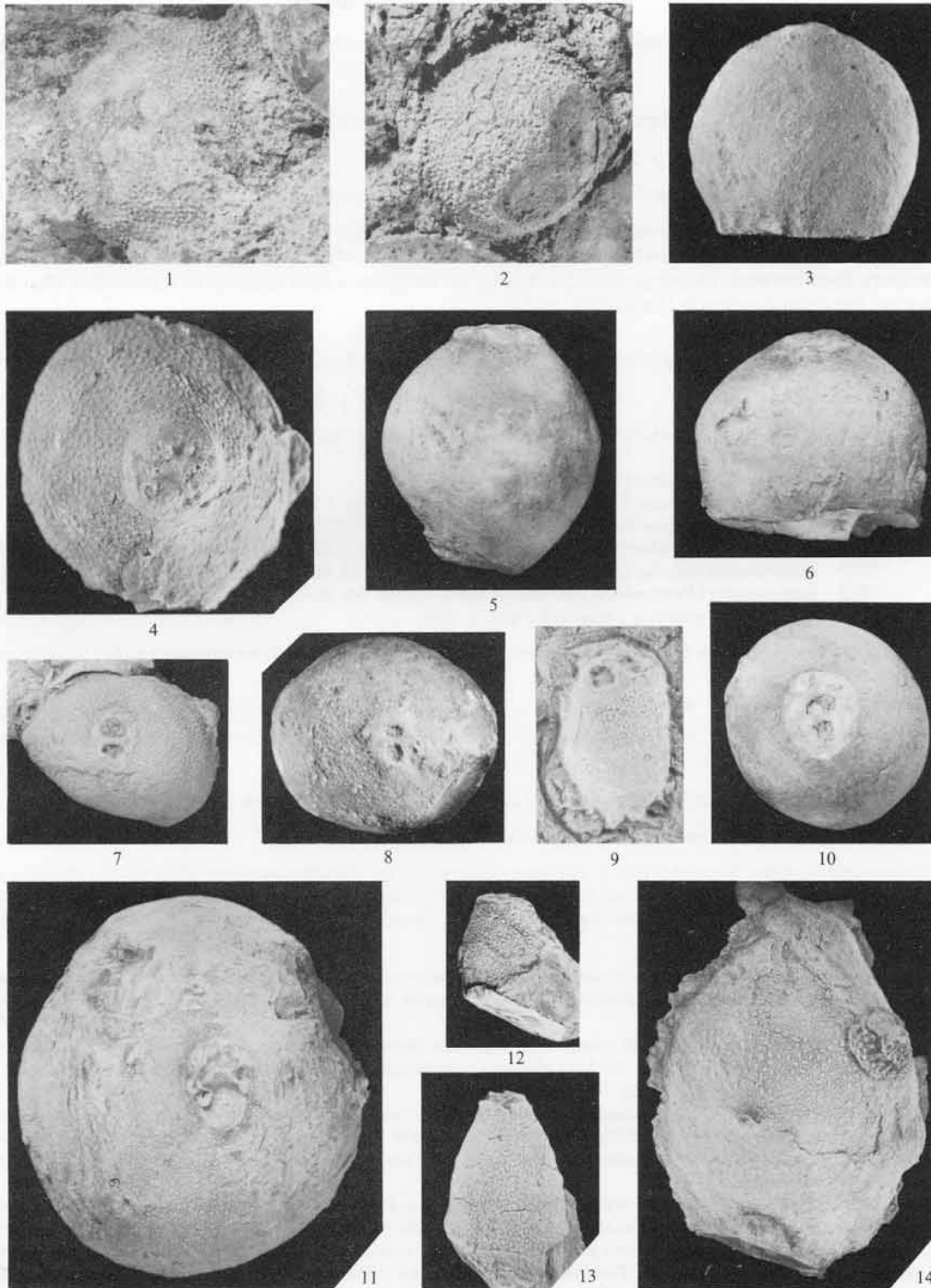

PAUL and BOCKELIE, *Sphaeronites*

thecal surface without short spines, and the consistently smaller size, when taken together, clearly indicate a distinct species.

Subgenus *Sphaeronites* (*Peritaphros*) Paul, 1973

1973 *Peritaphros* Paul, p. 21, text-fig. 13b.

*Type species.* *Sphaeronites globulus* Angelin, 1878, by original designation.

*Diagnosis.* A subgenus of *Sphaeronites* with generally polygonal diplopores which lack spines or tubercles on the ridges between the peripores but have a large, often H-shaped, central tubercle on the peripore floor between the perpendicular canals; the peripore is thus reduced to a moat-like channel around the central tubercle (Paul 1973, p. 23).

*Sphaeronites* (*Peritaphros*) *globulus* (Angelin, 1878)

Plate 72, fig. 11; text-figs. 5b, 17c, 26

- 1945 *Sphaeronites globulus* (Angelin); Regnéll, p. 168, pl. 11, figs. 10, 11; pl. 12, figs. 1, 3, 5; pl. 13, fig. 1; text figs. 19: 4, 5.  
 1948 *Sphaeronites globulus* (Angelin); Regnéll, p. 28.  
 non 1950 *Sphaeronites globulus* Termier and Termier, pl. 228, fig. 1.  
 1967 *Sphaeronites pomum* Kesling, non Gyllenhaal, p. fig. 142: 1a.  
 1967 *Sphaeronites globulus* (Angelin); Kesling, p. S243, fig. 142: 1c-e [non fig. 142: 1f. (= *Eucystis*)].  
 1972 *Sphaeronites globulus* (Angelin); Paul, p. 25, pl. 5, fig. 3; text-fig. 7a.  
 1973 *Sphaeronites* (*Peritaphros*) *globulus* (Angelin); Paul, pp. 20–22, 24.  
 1978 *Sphaeronites globulus* (Angelin); Paul, p. 283.

Once again Regnéll (1945, p. 168) gives a complete synonymy prior to 1945 and we have only added more recent references.

*Diagnosis.* A species of *Peritaphros* with moderately large spherical theca (reaching 35–40 mm diameter); diplopores with a well-developed central tubercle which is flat-topped and level with the peripore rims; four to five diplopores per mm<sup>2</sup>.

*Types.* Holotype, RM Ec4360, from the Dalby Limestone, the old harbour, Bödahamn, Öland.

*Material.* Several hundred specimens, mostly from Öland.

*Horizons and localities.* Regnéll (1945, p. 171) gives a thorough list of known localities, although the mention of 'Norway' probably refers to *S. (P.) pauciscleritatus* sp. nov. Most of our specimens come from the type locality in the Dalby Limestone of the old harbour at Bödahamn, Öland. *S. (P.) globulus* probably ranges through the lower half of the Caradoc.

*Description.* Theca: generally spherical with small oral platform and aboral attachment area. The theca reaches 35 mm diameter and the surface appears to be fairly smooth due to the flat-topped central tubercles of the diplopores.

Plates: fairly numerous (about 350 estimated in a 30 mm diameter theca), small to medium sized (mean area 7–8 mm<sup>2</sup>) and irregularly arranged. All bear numerous diplopores and none is tumid, the theca often having a regularly spherical outline (Pl. 72, fig. 11).

Diplopores (text-figs. 5b, 17c): densely packed and characteristic of the subgenus *Peritaphros* with a large, often H-shaped, central tubercle which is flat-topped and level with the peripore rims. Peripores reach 0.40–0.45 mm across, with a pair of pores about 0.1 mm in diameter and separated by 0.20–0.25 mm. Peripore rims are narrow and sharp edged.

Oral surface (text-fig. 26): a small oral platform is developed. It reaches 7 × 5 mm and includes the mouth and anus as usual. Almost invariably the mouth is covered by the six palatal plates and it reaches 2.5 × 3.0 mm. Ambulacral facets are often preserved (Pl. 72, fig. 11) and one or two occur per ambulacrum. Nine is the maximum number we have counted. The facets are small, close to the edge of the peristome, and food entered the mouth via minute ambulacral orifices. The anus is oval, up to 3 mm across and covered by an anal pyramid of six plates (Pl. 72, fig. 11). The mouth and anus are separated by about 0.5 mm in most specimens. The gonopore is a

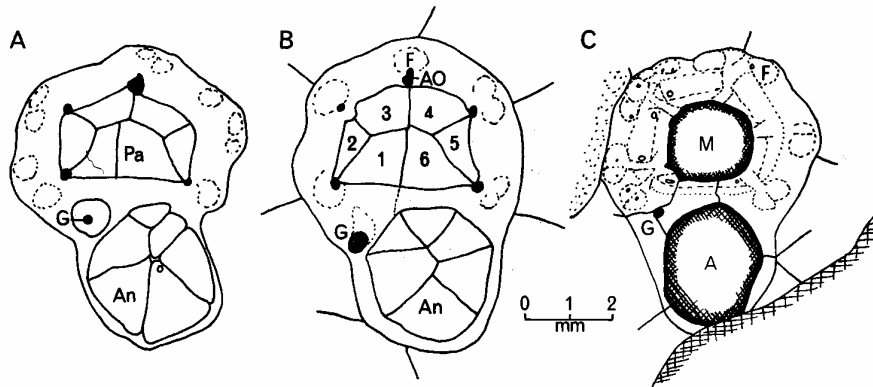

TEXT-FIG. 26. Camera lucida drawings of the oral area of *Sphaeronites (Peritaphros) globulus*. A, SM A85681, B, SM A85689, C, SM A85701, all from the Dalby Limestone, Bödahamn, Öland, Sweden. 1-6, oral cover plates (palatals, Pa); A, anus; An, anal cover plates; AO, ambulacral orifice; F, ambulacral facet; G, gonopore; M, mouth.

small circular orifice, up to 0.5 mm in diameter and sometimes raised in a tubular protuberance adjacent to the anal pyramid and ambulacral facet I (e.g. Pl. 12, fig. 11). Of all species *S. (P.) globulus* and, to a lesser extent, *S. (P.) variabilis* sp. nov. have the best-preserved oral surfaces.

Internal structures: grinding down the aboral part of the theca has revealed a hollow internal spine which seems to be characteristic of the subgenus *Peritaphros*.

Attachment: direct by a small, usually flat, attachment area. We have seen no example still attached to its substrate.

**Remarks.** Although *S. (P.) globulus* was the first species of *Peritaphros* to evolve, its diplopores are quite typical of the subgenus and already quite different from those of *S. (S.) minor* and *S. (S.) pomum*. The diplopore density is about the same as in the much older *S. (S.) pomum* and it seems that the main evolutionary change between the two species involved the type of diplopore. Once established, *Peritaphros* diplopores continued the trend towards lower densities. *S. (P.) globulus* occurs at Bödahamn in very large numbers accompanied by three other cystoid species which are also very common. They are *Echinosphaerites aurantium* (Gyllenhaal, 1772), *Caryocystites dubia* (Angelin, 1878), and *Lophotocystis granatum* (Wahlenberg, 1818). Of these, *S. (P.) globulus* and *E. aurantium* are consistently better preserved and we have seen only one example of *S. (P.) globulus* without the oral and anal cover plates still in place (text-fig. 26C).

*Sphaeronites (Peritaphros) pauciscleritatus* sp. nov.

Plate 73, fig. 1; text-fig. 27

- 1865 *Echinosphaerites pomum* var. Kjerulf, p. 4 (*pars.* ?).
- 1879 *Echinosphaerites pomum* Kjerulf, pl. 11 (*pars.* ?).
- 1887 *Echinosphaerites aurantium* Brögger, p. 21.
- 1934 *Echinosphaerites aurantium* Størmer, p. 331.
- 1945 *Glyptosphaerites* sp. Regnéll, p. 25.
- 1945 *Sphaeronites globulus* (Angelin); Regnéll, pp. 161, 171 (*pars.* ?).
- 1948 *Echinosphaerites aurantium* (Gyllenhaal); Regnéll, p. 21.
- 1948 *Glyptosphaerites* sp. Regnéll, p. 21.
- 1948 *Sphaeronites pomum* Regnéll, p. 31 (*pars.* ?).
- 1953 Diploporite cystoid Størmer, p. 65.
- 1967 *Glyptosphaerites* sp. Kesling, p. S145, text-fig. 67.
- 1978 *Sphaeronites* Bockelie, p. 198, fig. 3a.
- 1978 *Sphaeronites pauciscleritatus* Paul, p. 283 (*nomen nudum*).

**Diagnosis.** A species of *Peritaphros* with large globular theca reaching 40–50 mm in diameter in adult specimens; thecal plates limited (fifty to sixty); diplopores polygonal ( $0.4 \times 0.4$  to  $0.4 \times 0.6$  mm in adult specimens), average diplopore pore density  $3.7$  per  $\text{mm}^2$ .

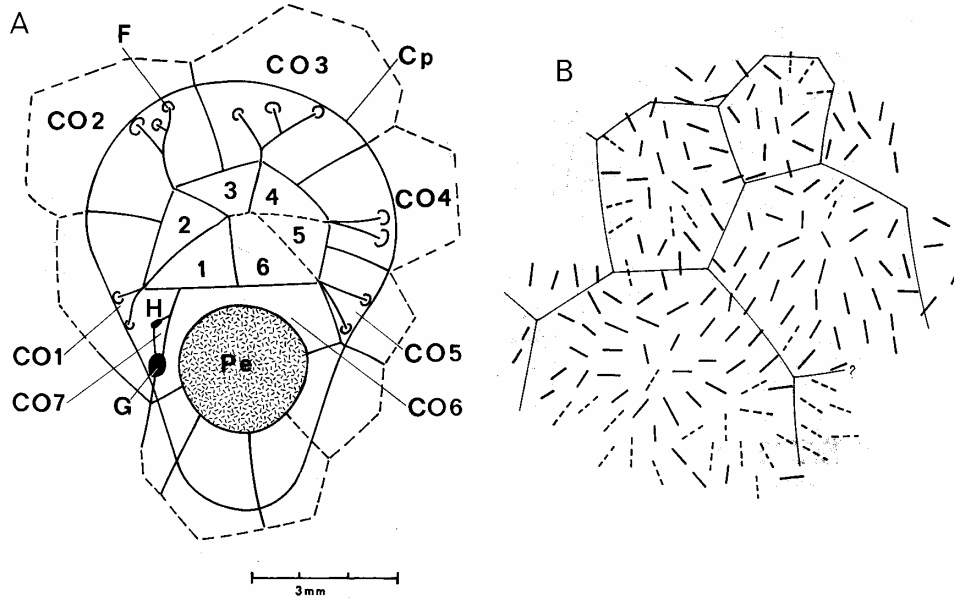

TEXT-FIG. 27. A, camera lucida drawing of the oral area of *Sphaeronites (Peritaphros) pauciscleritatus* sp. nov. Holotype, PMO 79687, Stage 4b $\beta$ , Oslofjord. 1–6, oral cover plates (palatals); CO1–CO7, circum-oral plates; F, ambulacral facets; G, gonopore; H, hydropore; Pe, periproct. B, traces of axes of diplopores in *Sphaeronites (Peritaphros) pauciscleritatus* sp. nov., PMO 79687, Stage 4b $\beta$ , Oslofjord.

#### EXPLANATION OF PLATE 73

- Fig. 1. *Sphaeronites (Peritaphros) pauciscleritatus* sp. nov., Lower Chasmops Limestone, Hareholmen, Ostøya, Baerum, Norway. Oral view of latex of paratype, PMO 90042, to show large size and characteristic polygonal diplopores.
- Figs. 2, 5, 8. *Sphaeronites (Ataphros) insuliporus* sp. nov., Shoeshook Limestone, Shoeshook, South Wales. 2, lateral and 5, oral views of the holotype, SM A85708. 8, detail of diplopores on SM A82024, to show lack of peripores characteristic of the subgenus *Ataphros*; latex,  $\times 4$ .
- Figs. 3, 7. *Sphaeronites (Peritaphros) litchi* (Forbes), Shoeshook Limestone, Shoeshook, South Wales. 3, oblique oral view of SM A31230, a specimen with damaged plates which reveal the growth lines. 7, detail of diplopores on SM A31233 showing prominent central tubercles and moat-like peripores characteristic of the subgenus *Peritaphros*;  $\times 6$ .
- Fig. 4. *Sphaeronites (Peritaphros)* sp. A. Dolhir Beds, Glyn Ceiriog, North Wales. Latex of SM A53853 to show very large diplopores;  $\times 6$ .
- Fig. 6. *Sphaeronites (Sphaeronites) pomum* (Gyllenhaal), Orthoceras Limestone, near Råbäck, Kinnekulle, Västergötland, Sweden. Detail of diplopores on SM A52977, a weathered specimen showing the oval sunken peripores characteristic of the subgenus *Sphaeronites s.s.*;  $\times 6$ .
- All specimens whitened with ammonium chloride sublimate;  $\times 2$  unless otherwise indicated.



1



2

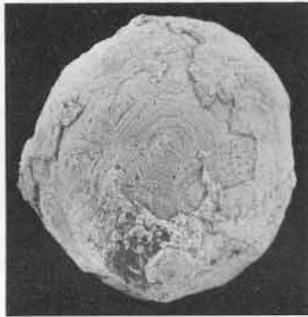

3

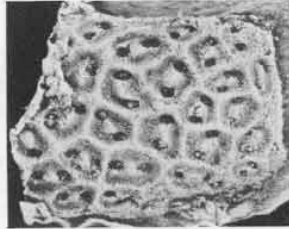

4



5

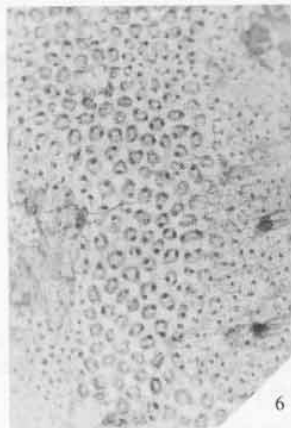

6

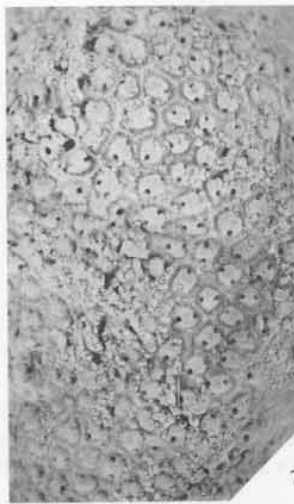

7



8

PAUL and BOCKELIE, *Sphaeronites*

*Derivation of name.* From Latin *pauci* = few, and Greek *scleros* = skeletal plate.

*Types.* Holotype, PMO 79687; paratypes, PMO 6183, 90042, 90043, 90289, 90293, 90297, 90347, 90349, 90350, 90351.

*Material available.* Holotype and a dozen paratypes.

*Horizon and locality.* Middle part of lower Chasmops Limestone (= Stage 4b $\beta$ ), middle Caradoc, Oslo-Asker District of the Oslo Region, Norway.

*Description.* Theca: globular, large, usually 30–50 mm in diameter in adult specimens; surface fairly smooth. Oral platform flat, slightly elevated. Attachment area variable.

Plates: not numerous (approximately fifty), fairly regularly arranged, usually pentagonal or hexagonal, each measuring about 10  $\times$  10 mm in average specimens. The centre of individual plates is slightly elevated so that sutures are weakly impressed. Numerous diplopores are present on the thecal plates, about thirty-five occur on a plate which measures 4  $\times$  5 mm (text-fig. 27B).

Diplopores: distributed over thecal surface, but only occasionally crossing plate sutures. In most cases, a narrow zone adjoining the plate sutures is devoid of peripores as in *S. (S.) pomum*. The periporal walls are generally high towards plate centre, decreasing towards the plate margins, which is also the case in *S. (S.) pomum*. In *S. (P.) globulus* the periporal wall is generally lower and slightly thicker. Peripores polygonal, often irregular pentagonal or hexagonal (Pl. 73, fig. 1). Peripore floors generally flat with a broad, constricted central tubercle. Peripores large, reaching 0.40 to 0.60 mm in major dimension (usually length) and contain a pair of pores 0.05 mm in diameter and set about 0.20 mm apart. Diplopore density averages 3.7 per mm<sup>2</sup> (110 measurements from eleven specimens, standard deviation 0.4 mm).

Oral surface (text-fig. 27A): a little below the external surface, the peristome appears elliptical, measuring 3.6  $\times$  5.0 mm in the holotype and 3.3  $\times$  5.0 mm in PMO 90042. In the holotype three of the six palatals are preserved; in PMO 90042 they are all well preserved (Pl. 73, fig. 1). Twelve ambulacral facets in the holotype (text-fig. 27A); two in radii I, IV, and V and three in radii II and III; branching either directly from corners of, or as sidebranches off major grooves. The ambulacral facets are indistinct, but appear to have been semicircular or kidney shaped. The periproct is circular in the holotype, 2.5 mm in diameter and separated from the peristome by a calcite ridge 0.2–0.3 mm wide. The periproct is usually larger than the peristome, but in the holotype the maximum dimensions are the same (3.1 mm). Both orifices are surrounded by a smooth, pear-shaped rim free of diplopores which form the oral platform. Six triangular anal plates cover the periproct in PMO 6183. The circular gonopore is usually large, being up to 1 mm in diameter in the largest specimens (Pl. 73, fig. 1). It is present left of the peristome and periproct, and often almost in contact with the central portion of the left side of the periproct. An elongated hydropore is located on the suture O1:O6 just adoral to the gonopore. The hydropore is 0.4  $\times$  0.3 mm in PMO 90042.

Internal structures: the internal spine or remains of it have been found in several specimens.

Attachment: direct by a variable attachment area.

*Remarks.* *S. (P.) pauciscleritatus* has been known to occur in Norway since Kjerulf (1865), but has never been described. Kjerulf, who referred it to '*Echinospaerites pomum*', may have been aware of the presence of the diplopores. Subsequent authors, however, have referred it to *Echinospaerites aurantium*. This species is very distinctive because of its great size and relatively few, large plates.

*Sphaeronites (Peritaphros) variabilis* sp. nov.

Plate 72, figs. 5, 6, 10; text-figs. 6, 13, 17D, 28

- 1945 Cystoid; gen. et sp. indet. Regnéll, p. 183, pl. 15, fig. 1.
- 1972 *Sphaeronites* sp. nov. (Skålberget, Sweden) Paul, p. 25, pl. 5, fig. 4.
- 1973 *Sphaeronites (Peritaphros)* sp. B, Paul, pp. 20–22, 24, text-figs. 10–12.
- 1978 *Sphaeronites variabilis* Paul, p. 283 (*nomen nudum*)

*Diagnosis.* A species of *Peritaphros* with theca generally higher than wide, with relatively few plates. Diplopores polygonal or rounded with wide, low rims and a central tubercle elevated slightly above the level of the rims. Pore density averages just over three diplopores per mm<sup>2</sup>.

*Types.* Holotype, the well-preserved specimen (SGU unregistered) originally figured by Regnéll (1945, pl. 15, fig. 1), from Gulleråsen, Dalarna.



**Material.** Holotype and several dozen paratypes, PMO, RM, SM and authors' collections.

**Horizons and localities.** This species first appears in bedded limestones equivalent to the Skålberg Beds about 5 m below the top of the Fjäckå Shale on the south side of the quarry at Osmundsberget, Dalarna, Sweden. These specimens are larger than all younger individuals and not very well preserved. The bed has now been quarried away completely. Above the Fjäckå Shale, *S. (P.) variabilis* occurs through the lower half of the Boda Limestone. The species ranges from perhaps as low as the upper Onnian to perhaps as high as the lower Rawtheyan, but both limits are uncertain. Our specimens come from the Boda Limestone at Skålberget, Osmundsberget, Gulleråsen and Boda Church, Dalarna.

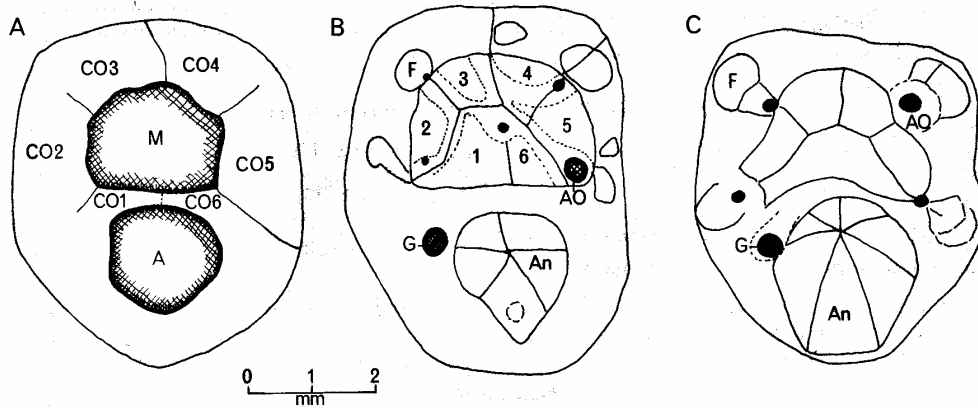

TEXT-FIG. 28. Camera lucida drawings of the oral area of *Sphaeronites (Peritaphros) variabilis* sp. nov. A, RM Ec25954; B, RM Ec25944; C, PMO A35423. All from the Boda Limestone, Osmundsberget (A) and Skålberget (B and C), Dalarna, Sweden. 1-6, oral cover plates (palatals); A, anus; An, anal cover plates; AO, ambulacral orifice; CO1-CO6, circum-oral plates; F, ambulacral facets; G, gonopore; M, mouth.

**Description.** Theca: variable in shape, pyriform, fusiform, or hemispherical, sometimes very irregular in shape (cf. Pl. 72, figs. 5, 6), with a fairly prominent oral platform and variable attachment area. Theca usually 15-25 mm in diameter, but reaching 50 mm high and 30 mm in diameter in the specimens from below the Fjäckå Shale at Osmundsberget. The surface is fairly smooth, but this has sometimes been enhanced by pressure solution (e.g. Pl. 72, fig. 5).

Plates: not very numerous (rarely, if ever, over seventy, certainly less than 100), arranged fairly regularly in four to six circlets of about ten plates, although the basal circlet has only seven. Plates polygonal in outline and moderately large, reaching an average area of 40 mm<sup>2</sup> in some specimens. Diplopores are developed on all plates.

Diplopores (text-fig. 17D): evenly distributed over the theca with a density of three per mm<sup>2</sup>. Outlines polygonal or occasionally rounded, with the central tubercle projecting above the level of the peripore rims, which are wider than in any other species except *S. (P.) pyriformis* (Forbes). Peripores relatively large, exceeding 0.5 mm across, with a pair of pores 0.07 mm in diameter and up to 0.45 mm apart.

Oral surface (text-fig. 28): a generally prominent oral platform is present which reaches 10.2 × 6.5 mm and contains both the peristome and periproct as usual in *Sphaeronites* (Pl. 72, fig. 10). Peristome reaches 2.5 × 3.6 mm and is generally covered by the six palatals (text-fig. 28). The ambulacral facets are close to the edge of the peristome, small, and one or two occur per ambulacrum. At least five examples we have seen lacked facets in ambulacrum III, an exceedingly rare feature. The periproct is circular, up to 3 mm in diameter and covered by six anals. The peristome and periproct are separated by at least 0.5 mm and more than 1 mm in some specimens. The circular gonopore is relatively large and reaches 0.7 mm diameter. A smaller hydropore 0.3-0.4 mm across is also present in some specimens between the gonopore and the peristome.

Internal structures: an aboral internal spine, which is partly hollow and partly C-shaped in section, occurs in several specimens we have sectioned, including the one illustrated in text-fig. 6.

Attachment: direct by a variable attachment area which is generally oval in outline. A few examples are known still attached to other cystoids and in one case to a crinoid stem. As usual, the shape and size of the attachment area reflect the nature of the substrate.

*Remarks.* As the name implies, *S. (P.) variabilis* is not characterized by a regular thecal shape. Of the other species, only *S. (P.) pyriformis* displays anything like the variability in thecal shape found in *S. (P.) variabilis*. Specimens also vary in size and those from below the Fjäckå Shale at Osmundsberget are consistently much larger than all later examples. It is possible that they represent a distinct species, but so far we have been unable to find any other character than size on which to distinguish them. Quite possibly the bed represents a population which became fully grown in stable conditions before being buried, whereas most of the later examples died relatively young on the unstable slopes of the Boda bioherms. For the present it seems to us best to include all these specimens in one species. The holotype, however, is from the Boda Limestone flank facies.

*Sphaeronites (Peritaphros) litchi* (Forbes, 1848)

Plate 72, figs. 4, 14; Plate 73, figs. 3, 7; text-figs. 17F, 29

- 1973 *Sphaeronites (Peritaphros) litchi* (Forbes); Paul, p. 23, pl. 1, figs. 2, 7-9, 12-15; pl. 2, figs. 1, 2; pl. 10, fig. 9; text-figs. 15, 16.  
1978 *Sphaeronites litchi* (Forbes); Paul, p. 283.

For a full synonymy of this species see Paul 1973, p. 23.

*Diagnosis.* A species of *Peritaphros* with fusiform to globular theca; polygonal diplopores with very prominent central tubercles elevated above the level of the sharp-crested peripore rims; about two and a quarter diplopores per mm<sup>2</sup>.

*Type.* GSM 7431a (Pl. 72, figs 14), the original of Forbes 1848, pl. 21, figs. 2c, d, was selected as lectotype by Paul 1973, p. 23.

*Material available.* About twenty more or less complete thecae, GSM, HM, SM, PMO.

*Horizons and localities.* The lectotype is from the Sholeshook Limestone (Ashgill, zones 2-5) at Sholeshook, near Haverfordwest, South Wales. *S. (P.) litchi* occurs between 13 and 37 m in the Sholeshook section. It also occurs

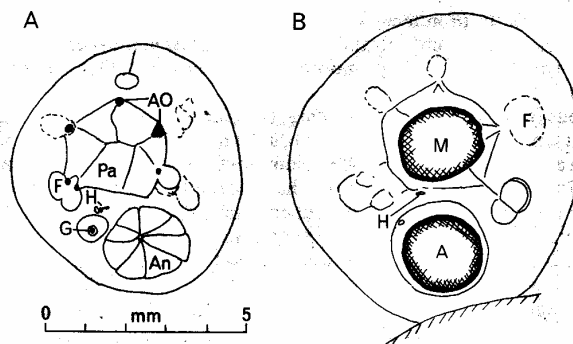

TEXT-FIG. 29. Camera lucida drawings of the oral area of *Sphaeronites (Peritaphros) litchi*. A, SM A85706, B, PMO A37047, both from the Sholeshook Limestone, Sholeshook, South Wales. A, anus; An, anal cover plates; AO, ambulacral orifices; F, ambulacral facet; G, gonopore; H, hydropore; Pa, palatal plates.

in the Shoeshook Limestone at Llandowror, South Wales and the Rhiwlas Limestone (Ashgill, zone 5) at Rhiwlas, near Bala, North Wales.

*Description.* Theca: inflated fusiform to pyriform and up to 45 mm in height and 35 mm in diameter. Peristome and periproct close together on a small oral prominence. Usually with an attachment area up to half the ambital diameter.

Plates: precise arrangement unknown, of two generations, the primaries reaching 6–7 mm in major dimension. All plates except those forming the attachment area, covered with evenly developed diplopores which give the surface a rough appearance.

Diplopores (text-fig. 17F): polygonal in outline, with narrow, sharp-crested peripore rims and a very prominent central tubercle which rises 0.20–0.25 mm above the plate surface (Pl. 73, fig. 7). Peripore tubercle often H-shaped. Pores 0.10–0.17 mm in diameter and 0.25–0.33 mm apart. Diplopore density averages 2.26 per mm<sup>2</sup>.

Oral surface (text-fig. 29): a prominent oral platform is developed which reaches 9 × 7 mm in the largest examples and contains the mouth and anus (Pl. 72, fig. 4). Peristome 2.5 × 2 mm, anus more rounded and 2–3 mm in diameter. Six plates surround the mouth which is separated from the anus by 0.25–0.4 mm. Mouth covered by the usual six palatal plates and the anus by a pyramid of eight anals (Pl. 72, fig. 4; text-fig. 29A). A small circular gonopore 0.2 mm in diameter is present in SM A85706. Sometimes it is raised as a tubercle (Pl. 72, fig. 4).

Internal structures: a tubular aboral internal spine is preserved in GSM 102380. The tube is 3.5 mm in diameter and 8.6 mm long.

Attachment: direct by a variable aboral attachment area, usually from a fifth to nearly half the maximum diameter (Pl. 72, fig. 14).

*Remarks.* A full account of the nomenclatural history of this species is given by Paul (1973, pp. 23–25). The species is very distinctive and can be recognized by the prominent central tubercle in the diplopores which gives the external surface a very rough appearance.

*Sphaeronites (Peritaphros) pyriformis* (Forbes, 1848)

Plate 72, figs. 9, 12, 13; text-figs. 17E, 30

1973 *Sphaeronites (Peritaphros) pyriformis* (Forbes); Paul, p. 25, pl. 1, 3, 4, 6, 10, 11; text-fig. 17. [See for full synonymy].

*Diagnosis.* A small species of *Peritaphros* with pyriform to cylindrical theca not more than 15 mm high; oval to subangular diplopores with flat-topped central tubercles, diplopore density averaging two and a half diplopores per mm<sup>2</sup>.

*Types.* GSM 102360 (Pl. 72, fig. 9), the original of Forbes 1848, pl. 21, figs. 1a–b, was selected as lectotype by Paul 1973, p. 26. GSM 102361–2 are paralectotypes.

*Material available.* About twenty more or less complete thecae. GSM, BM(NH), SM, PMO.

*Horizons and localities.* Rhiwlas Limestone (Ashgill, zone 5) at Rhiwlas and Llwyn-y-Ci, near Bala, North Wales.

*Description.* Theca: conical (Pl. 72, figs. 12, 13) to fusiform or irregular, bent through 180° in one example. Always small, up to 13 mm high and 10 mm in diameter. Peristome and periproct close together on oral prominence which is almost as wide as the entire theca (Pl. 72, fig. 9). Attached directly by a relatively large attachment area.

Plates: usually between twenty-five and thirty-five, arranged in four circlets of seven or eight plates each, all of one generation. Plates reach 5 mm in maximum dimension and all bear diplopores.

Diplopores (text-fig. 17E): rather sparsely developed and hence frequently oval in outline (Pl. 72, figs. 9, 12, 13). With broad flat-topped peripore rims and large flat-topped central tubercle level with the peripore walls. Less evenly developed than in other species of *Sphaeronites s.l.* Diplopore density averages 2.6 per mm<sup>2</sup>.

Oral surface (text-fig. 30): peristome small, oval to rounded, 2.5 × 1.9 mm in the lectotype. Surrounded by CO1–CO6, CO7 not confirmed. Apparently only one ambulacral facet per ambulacrum; facets rounded and 0.80–0.85 mm in diameter in GSM 102362 and the lectotype. Facets generally poorly preserved and difficult to detect. Palatal and anal plates not preserved (in contradiction to Forbes's 1848, pl. 21, fig. 1b). Periproct

rounded-oval, 1.9 mm in diameter in lectotype. Gonopore a small circular pore 0.5 mm in diameter to the left of the peristome and periproct and developed across a plate suture between CO1 and CO6 or CO7; precisely which is uncertain. Double in BM(NH) E16347. Hydropore not detected.

Internal structures: unknown.

Attachment: direct by an aboral attachment area which may be the widest part of the theca. Attachment is often oblique to the ad-aboral axis and may extend up one side of the theca (e.g. BM(NH) E16345). BM(NH) E16346 attached to a crinoid root structure.

TEXT-FIG. 30. Camera lucida drawing of the oral area of *Sphaeronites* (*Peritaphros*) *pyriformis* BM(NH) E16347, Rhiwlas Limestone, Llwyn-y-Ci, North Wales. A, anus; G, gonopore; M, mouth.

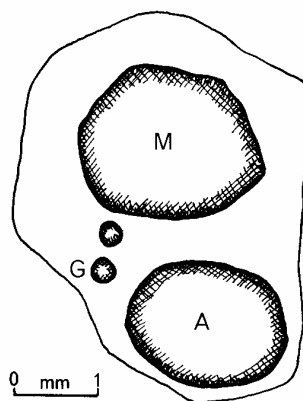

*Remarks.* *S. pyriformis* is known from a moderate number of specimens, all of which are smaller than those of any other species of *Sphaeronites* s.l. This may reflect an environmental peculiarity of the Rhiwlas Limestone; all specimens could have become detached and buried before maturing; or *S. pyriformis* could be a genuinely small species. In either event available material is quite distinct from all other species on the basis of size alone. Forbes's original type set contained four specimens of which one, GSM 7432, is much larger and has angular diplopores with very prominent central tubercles. On these grounds Paul (1973, p. 27) assigned this specimen to *S. (P.) litchi*. We have since found at least one more specimen of *S. (P.) litchi* in the Rhiwlas Limestone. The possibility that *S. (P.) pyriformis* represents the juvenile stage of *S. (P.) litchi* still remains and will continue to do so until a really small example of the latter is found.

#### *Sphaeronites* (*Peritaphros*) sp. A

Plate 73, fig. 4

1972 *Sphaeronites* sp. Paul, p. 25.

1973 *Sphaeronites* (*Peritaphros*) sp. A, Paul, p. 27, pl. 1, fig. 5.

*Material available.* A single specimen, SM A53853, which is an external mould of a small fragment of theca.

*Horizon and locality.* Dolhir Limestone (Ashgill, zone 2) from an old tram cutting ENE of Coed-y-Glyn-Isaf, Glyn Ceiriog, North Wales.

*Description.* A small portion of theca 6.5 × 4.3 mm which preserves about twenty-six diplopores (Pl. 73, fig. 4).

Diplopores: large for *Peritaphros* (1–1.5 mm in major dimension), polygonal, with a relatively weak central tubercle. Peripore rims strongly developed but not flat-topped. Diplopore density averages 1.5 per mm<sup>2</sup>, which is nearly half that of any other species of *Peritaphros*.

All other features of morphology unknown.

*Remarks.* The diplopores of SM A53853 show closest similarities to those of *Peritaphros* spp., but they are much larger and much less densely developed than in any described species. Most

likely this small fragment represents a new species but it is unsuitable to become the type of a new species.

Subgenus *Sphaeronites* (*Ataphros*) subgen. nov.

*Type species.* *Sphaeronites* (*Ataphros*) *insuliporus* sp. nov.

*Diagnosis.* A subgenus of *Sphaeronites* with diplopores which lack any peripores, the perpendicular canals opening on either side of a small central tubercle.

*Sphaeronites* (*Ataphros*) *insuliporus* sp. nov.

Plate 73, figs. 2, 5, 8; text-figs. 5c, 31, 32

1973 *Diploporita incertae sedis* sp. D, Paul, p. 61, pl. 10, figs. 3, 5, 6; text-fig. 38b.

*Diagnosis.* As for the subgenus which is monotypic.

*Types.* Holotype SM A85708, a nearly complete theca. Paratypes SM A82024, 5, two small fragments of external mould.

*Material.* The three specimens listed above.

*Horizons and localities.* Sholeshook Limestone (Ashgill, zones 2-5) between 11.6 and about 35 m in the railway cutting at Sholeshook, South Wales. The holotype came from a loose block between 34 and 37 m.

*Description.* Theca: fusiform in the holotype (Pl. 73, fig. 2) which is slightly crushed and measures 29 mm high by about 15 mm in maximum diameter which occurs about two thirds of the height (text-fig. 32). Both ends of the theca are extended to form the oral platform and the attachment area.

Plates: relatively few, probably less than fifty and apparently arranged in six circlets. They reach 6-7 mm across. All are apparently very thin, about 0.35 mm thick, which may account for the rarity of the species and the fragmental nature of the first specimens found. All are covered with diplopores.

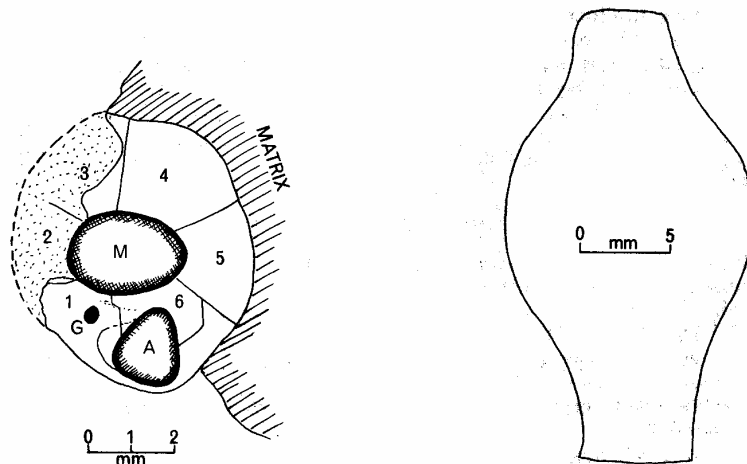

TEXT-FIG. 31 (left). Camera lucida drawing of the oral area of *Sphaeronites* (*Ataphros*) *insuliporus* sp. nov. Holotype, SM A85708, Sholeshook Limestone, Sholeshook, South Wales. 1-6, circum-oral plates; A, anus; G, gonopore; M, mouth.

TEXT-FIG. 32 (right). Camera lucida drawing of the thecal outline of the holotype of *Sphaeronites* (*Ataphros*) *insuliporus* sp. nov., SM A85708.

Diplopores (text-fig. 5c): evenly, but rather sparsely developed for a species of *Sphaeronites*. All lack peripores (Pl. 73, fig. 8), but the small perpendicular canals, 0.08 mm in diameter in the holotype, lie on either side of a central tubercle and are about 0.1 mm apart centre to centre. The central tubercles of the diplopores resemble those of *Peritaphros* spp.

Oral surface (text-fig. 31): a prominent, flat-topped oral platform about 3 mm in diameter occurs (Pl. 73, fig. 5). The peristome and periproct lie close together within this (Pl. 73, fig. 5) indicating that it is a species of *Sphaeronites* as here defined. A small circular gonopore 0.25 mm in diameter and possibly a slit-like hydropore lie between the mouth and anus and to the left. The mouth is oval, about 3 × 2 mm, while the anus is more irregular and about 2 mm across. The oral area is deeply weathered which reveals plate sutures, but not ambulacral facets. The usual six plates make up the peristome frame.

Internal structures: unknown.

Attachment: direct by a small rather expanded attachment area about 7.5 mm across.

*Remarks.* Paul (1973, p. 61) first reported this cystoid on the basis of two incomplete external moulds which had unusual diplopores. He remarked that the diplopores in some ways resembled those of *Peritaphros* spp., but was unable to say more. By extraordinary good fortune we are now able to identify this species. While collecting at Shoeshook in 1974 we found a cystoid in a small piece of rock which split so that most of the theca remained in one part, but a small fragment attached to the other. On decalcifying the small part we discovered that it had diplopores like the hitherto unidentifiable fragments (SM A82024-5). Meanwhile, the main body of the theca had the oral area exposed and confirmed the thecal shape and systematic affinities of the specimen. Without both parts, one preserved as the original theca and the other now as an external mould, we would not be able to identify this specimen.

The diplopores are so distinctive that although this is clearly a *Sphaeronites* on the basis of the arrangement of orifices and plates in the oral platform, it cannot be assigned to either *Sphaeronites* s.s. or *Peritaphros*. Hence we define a new subgenus, *Ataphros*, in allusion to the lack of peripores in this species.

*Acknowledgements.* We acknowledge our indebtedness to the following for access to, and/or the loan of, specimens: Dr. H. G. Owen and Dr. R. P. S. Jefferies, British Museum (Natural History), London (BM(NH)), Dr. A. W. A. Rushton, Institute of Geological Sciences, Geological Museum, London (GSM), Professor Gunnar Henningsmoen, Paleontological Museum, Oslo (PMO), Professor Valdar Jaanusson, Riksmuseum, Stockholm (RM), and Dr. R. B. Rickards, Sedgwick Museum, Cambridge (SM). We also thank Professor Jaanusson for access to unpublished maps and manuscript data on carbonate mounds in the Dalarna region, Sweden. Field-work for C.R.C.P. was supported by Reading University (1973), Liverpool University (1974-5), and N.E.R.C. Research Grant GR3/2630 (1976-8); J.F.B.'s field-work was supported by the Nansen Fund (1973-5), the Paleontological Museum, Oslo (1973-6) and the Norwegian Research Council for Science and Humanities (1977-9).

#### REFERENCES

- ANGELIN, N. P. 1878. *Iconographia crinoideorum in stratis Sueciae siluricis fossilium*. Holmiae, iv + 32 pp., 29 pls. *Opus posthumum* (ed. by LOVEN, S. and LINDSTRÖM, G.).
- BASSETT, D. A., WHITTINGTON, H. B. and WILLIAMS, A. 1966. The stratigraphy of the Bala district, Merionethshire. *Q. Jl geol. Soc. Lond.* **122**, 219-271, pl. 11.
- BASSLER, R. S. and MOODEY, M. W. 1943. Bibliographic and faunal index of Paleozoic pelmatozoan echinoderms. *Spec. Pap. geol. Soc. Am.* **45**, i-vi, 1-733.
- BATHER, F. A. 1900. The echinoderms. In LANKESTER, E. R. (ed.) *A treatise on zoology*. Vol. 3. A. and C. Black, London, vi + 344 pp.
- BOCKELIE, J. F. 1978. The Oslo Region during the early Palaeozoic. In RAMBERG, I. B. and NEUMANN, E. R. (eds.). *Tectonics and geophysics of continental rifts*. Reidel, Dordrecht, 195-202.
- BRÖGGER, W. C. 1887. Geologisk kart over øerne ved Kristiania. *Nyt Mag. Naturvid.* **31**, 1-36.
- CHAUVEL, J. 1966. Échinodermes de l'Ordovicien du Maroc. *Cah. Paléont.* **1966**, 1-120, pls. 1-16.
- FARMANFARMAIAN, A. 1966. The respiratory physiology of echinoderms. In BOOLOOTIAN, R. A. (ed.). *Physiology of Echinodermata*. Wylie, New York, 245-265.
- FENNER, D. H. 1973. The respiratory adaptations of the podia and ampullae of echinoids (Echinodermata). *Biol. Bull. mar. biol. Lab., Woods Hole*, **145**, 323-339.

- FORBES, E. 1848. On the Cystideae of the Silurian rocks of the British Isles. *Mem. geol. Surv. U.K.* **2**, 483-538, pls. 11-23.
- GRAY, J. 1928. *Ciliary movement*. Cambridge University Press, Cambridge, 162 pp.
- GYLLENHAAL, J. A. 1772. Beskrifning på de så kallade Crystallåplen och kalkbollar, såsom petreficerade Djur af Echini genus, eller dess närmaste slågtingar. *K. svenska Vetensk.Akad. Handl.* **33**, 239-261, pls. 8, 9.
- HAECKEL, E. 1896. Amphorideen und Cystoideen. Beiträge zur Morphologie und Phylogenie. In *Festschrift zum Siebenzigsten Geburtstag von Carl Gegenbaur am 21 August 1896*. Vol. 1 Leipzig, 1-180, pls. 1-5.
- HECKER, R. F. [GEKKER, R. F.] 1964. Class Cystoidea. In HECKER, R. F. (ed.). *Osnovy Paleontologii*, **10**, Moscow, 30-45, pls. 2-5.
- HISINGER, W. 1828. *Anteckningar i Physik och Geognosi under resor uti Sverige och Norrige*. Vol. 4. Stockholm, x + 258 pp., 9 pls.
- HOLM, G. 1901. Kinnekulles Berggrund. *Sver. geol. Unders. Afh. Ser. C*, **172**, 1-70.
- JAEKEL, O. 1899. *Stammesgeschichte der Pelmatozoen. 1. Thecoidea und Cystoidea*. Julius Springer, Berlin, x + 442 pp., 18 pls.
- KESSLING, R. V. 1967. Cystoids. In MOORE, R. C. (ed.). *Treatise on invertebrate paleontology. S. Echinodermata 1(I)*. Geological Society of America and University of Kansas, New York and Lawrence, Kansas, S85-S267.
- KJERULF, T. 1865. *Veiviser ved Geologiske Excursioner i Christiania omegn*. Univ. program 2. halvår 1865, I-IV, 1-43.
- 1879. *Udsigt over det sydlige Norges Geologi*. P. F. Steensballes boghandel, Christiania (Oslo), 262 pp. Atlas of 39 pls., 1 map.
- KROGH, A. 1919. The rate of diffusion of gases through animal tissues, with some remarks on the coefficient of invasion. *J. Physiol.* **52**, 391-408.
- LINNAEUS, C. 1758. *Systema naturae, sive regna tria naturae systematice proposita per classes, ordines, genera et species*. Editio decima, reformata. Vol. 1. *Regnum Animale*. Laurentii Salvii, Holmia, ii + 824 pp.
- MOBERG, J. C. 1890. Anteckningar om Ölands ortocerkalk. *Sver. geol. Unders. Afh. Ser. C*, **109**, 11-22.
- MOSS, M. L. and MEEHAN, M. M. 1967. Sutural connective tissues in the test of an echinoid, *Arbacia punctulata*. *Acta anat.* **66**, 279-304.
- MÜLLER, J. 1854. Über den Bau der Echinodermen. *Abh. k. Akad. Wiss. Berlin*, **1853**, 125-220, 9 pls.
- NEUMAYR, M. 1889. *Die Stämme des Thierreiches. Wirbellose Thiere*. Wien and Prag, vi + 603 pp.
- NICHOLS, D. 1959a. The histology of the tube-feet and clavulae of *Echinocardium cordatum*. *Q. Jl microsc. Sci.* **100**, 73-87.
- 1959b. The histology and activities of the tube-feet of *Echinocyamus pusillus*. *Ibid.* **100**, 539-555.
- PAUL, C. R. C. 1971. Revision of the *Holocystites* fauna (Diploporita) of North America. *Fieldiana, Geol.* **24**, 1-166.
- 1972. Morphology and function of exothecal pore-structures in cystoids. *Palaeontology*, **15**, 1-28, pls. 1-7.
- 1973. British Ordovician cystoids. *Palaeontogr. Soc. [Monogr.]*, **1**, 1-64, pls. 1-11.
- 1977. Evolution of primitive echinoderms. In HALLAM, A. (ed.). *Patterns of evolution as illustrated by the fossil record*. Elsevier, Amsterdam, 123-158.
- 1978. Respiration rates in primitive (fossil) echinoderms. *Thalassia jugosl.* **12**, 277-286.
- PRICE, D. 1973. The age and stratigraphy of the Shoeshook Limestone of southwestern Wales. *Lpool Manchr geol. J.* **8**, 225-246.
- 1980. A revised age correlation for the topmost Shoeshook Limestone Formation (Ashgill) of South Wales. *Geol. Mag.* **117**, 485-489.
- PROSSER, C. L., BISHOP, D. W., BROWN, F. A., JAHN, T. L. and WULFF, V. J. 1950. *Comparative animal physiology*. W. B. Saunders & Co., Philadelphia, ix + 888 pp.
- REGNÉLL, G. 1945. Non-crinoid Pelmatozoa from the Paleozoic of Sweden. A taxonomic study. *Meddn. Lunds geol.-miner. Instn.* **108**, 1-255, pls. 1-15.
- 1948. An outline of the succession and migration of non-crinoid pelmatozoan faunas in the Lower Paleozoic of Scandinavia. *Ark. Kemi Miner. Geol.* **26A** (13), 1-55.
- 1960. The Lower Palaeozoic echinoderm faunas of the British Isles and Balto-scandia. *Palaeontology*, **2**, 161-179.
- RUTMAN, J. and FISHELSON, L. 1969. Food composition and feeding behaviour of shallow-water crinoids at Eilat (Red Sea). *Mar. Biol.* **3**, 46-57.
- SMITH, A. B. 1978. A functional classification of the coronal pores of regular echinoids. *Palaeontology*, **21**, 759-789, pls. 81-84.
- STØRMER, L. 1934. Cambro-Silurian zones of the Oslo region, with a brief correlaion between the British and Norwegian sections. In HOLTEDAHL, O., SCHETELIG, J., ROSENDAHL, H. and STØRMER, L. (eds.). *The geology of*

- parts of southern Norway. III. The geology of the Oslo region, and the adjacent sparagmite district. *Proc. Geol. Ass. Lond.* **45**, 329–337.
- 1953. The Middle Ordovician of the Oslo region, Norway. 1. Introduction to stratigraphy. *Norsk geol. Tidsskr.* **31**, 37–141, 6 pls.
- SUN, Y. C. 1948. The early occurrence of some Ordovician and Silurian cystoids from western Yunnan and its significance. *Palaeont. Novit.* **1**, 1–9, pl. 1.
- TERMIER, H. and TERMIER, G. 1950. *Paléontologie Marocaine. 2. Invertébrés de l'Ère primaire. 4. Annélides, Arthropodes, Échinodermes, Conularides et Graptolithes.* Masson et Cie, Paris, 279 pp., pls. 184–241.
- WAHLENBERG, G. 1818. Petrificata Telluris Svecanae examinata a Georgio Wahlenberg. *Nova Acta R. Soc. Scient. upsal.* **3**, 1–116, pls. 1–4.
- WAINWRIGHT, S. A., BIGGS, W. D., CURREY, J. D. and GOSLINE, J. M. 1976. *Mechanical design in organisms.* Edward Arnold, London, 423 pp.
- WEBSTER, S. K. and GIESE, A. C. 1975. Oxygen consumption of the purple sea urchin with special reference to the reproductive cycle. *Biol. Bull. mar. biol. Lab. Woods Hole*, **148**, 165–180.
- WESTERGÅRD, A. H. 1943. Den kambro-siluriska lagerserien. In JOHANSON, S., SUNDIUS, N. and WESTERGÅRD, A. H. (eds.). Beskrivning till Kartbladet Lidköping. *Sver. geol. Unders. Afh. Ser. Aa* **182**, 22–89.
- WHITTINGTON, H. B. 1968. A monograph of the Ordovician trilobites of the Bala area, Merioneth. *Palaeontogr. Soc. [Monogr.]*, **4**, 93–138, pls. 29–32.
- WILLIAMS, A., STRACHAN, I., BASSETT, D. A., DEAN, W. T., INGHAM, J. K., WRIGHT, A. D. and WHITTINGTON, H. B. 1972. A correlation of Ordovician rocks in the British Isles. *Spec. Rep. geol. Soc. Lond.* **3**, 1–74.
- ZITTEL, K. A. von. 1879. *Handbuch der Paläontologie. I. Protozoa, Coelenterata, Echinodermata und Molluscoidea.* München & Leipzig, viii + 765 pp.

C. R. C. PAUL

Jane Herdman Laboratories of Geology  
University of Liverpool  
Brownlow Street, P.O. Box 147  
Liverpool L69 3BX, U.K.

J. F. BOCKELIE

Norsk Hydro  
Research Centre  
Lars Hilles gate  
5000 Bergen, Norway

Manuscript received 14 October 1980

Revised manuscript received 22 December 1982